

BROADCAST NEWS



LIVE COLOR TELEVISION COMES TO LOUISVILLE



Vol. No. 117 June 1963

RCA
BC-7

Closest to Custom in a Production Console!



RCA Transistorized Console for Dual-Channel AM/TV and FM Stereo

Take a good look at this smart new model. Here's that "custom" appearance to satisfy the proudest management; "custom" quality and flexibility to please the most discriminating engineers...all in a production-model!

CUSTOM STYLING—Striking new lines in blue and silver bring a color accent to control rooms. Color-coded operating controls are engineered to avoid errors. Only 39" long, it is compact and self-contained...to satisfy new or existing arrangements.

CUSTOM QUALITY—The BC-7A is fully transistorized for long-term reliability. All amplifiers have input and output transformers...precise impedance matching for both program and monitoring circuits. You get quality stereo monitoring (10 watts out-

put), quality gain controls, quality leaf-type key switches on all program circuits.

CUSTOM FLEXIBILITY—You have interchangeable plug-in modules...preamplifiers, isolation/balancing units, program amplifiers, monitoring amplifiers, cue amplifier and power supply—all in one self-contained unit. You get three-mode operation...selector switch to instantaneously convert from dual channel, parallel or stereo operation.

We can't name them all here, but we believe you will agree that this is the kind of customized styling, quality, and flexibility you want. Let your Broadcast Representative show you all the features that make this console your best buy. Or write RCA, Broadcast and Television Equipment, Bldg. 15-5, Camden, N.J.

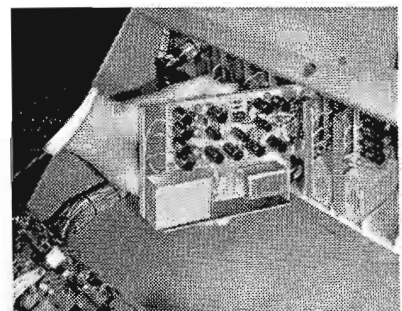

Plug-in flexibility... preamplifiers for low-level sources... isolation/balancing units for high level sources.

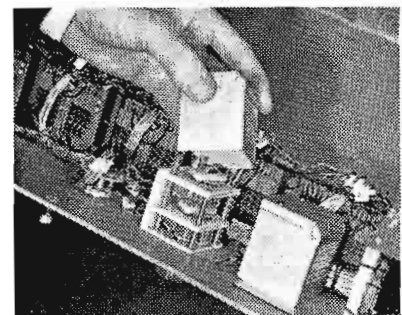

High quality mixers...ganged step-type attenuators when in stereo... individual step-type when in dual channel use.



THE MOST TRUSTED NAME IN ELECTRONICS

BROADCAST NEWS*published by***RADIO CORPORATION OF AMERICA**
BROADCAST & COMMUNICATIONS PRODUCTS DIVISION, CAMDEN, N. J.*issued quarterly*

PRICE *in U.S.A. - - - - - \$4.00 for 4 issues*
outside U.S.A. - - - \$5.00 for 4 issues

C O N T E N T S

	Page
INSTRUCTIONAL TELEVISION AT THE UNIVERSITY OF AKRON	12
BASIC TV TAPE RECORDER, TYPE TR-2	20
RCA EQUIPMENT DISPLAY AT 1963 NAB	25
WAVE-TV BRINGS LIVE COLOR TO LOUISVILLE	36
WRVA INSTALLS NEW RADIO FACILITIES	50
TV TOWER IN GEORGIA IS WORLD'S TALLEST	55
WRBL-TV OPERATING CHANNEL 3 FROM WORLD'S HIGHEST STRUCTURE	60
WTVM OPERATING CHANNEL 9 FROM WORLD'S HIGHEST STRUCTURE	64
JACK LEITCH RETIRES	68

*As We Were
Saying*

THE LONG STORY in this issue of BROADCAST NEWS concerns WAVE-TV, Louisville—especially its live-color operation. What we call a “long” story is a comprehensive and detailed description of a station’s overall facilities and operations. We’ve been doing one or more of these “stories” per issue ever since the first appeared in BROADCAST NEWS for April 1933 (see Page 68). Our thought is that such descriptions are of great usefulness to other station engineers when they

are planning new installations. Many of them have told us that they keep a permanent file of these station descriptions. When they get ready to plan a new installation of their own, they get out the file and go through it for ideas—both as to what to do, and what not to do.

Most of these stories, like the installations themselves, have their genesis in the mind of the station’s chief engineer. In the case of WAVE-TV we hardly need say that it was Wilbur Hudson



Model of the RCA Exhibit Building now under construction at the World's Fair site. Feature will be an elaborate color studio feeding programs throughout the Fair area (see note below).

who planned the layout, supervised the installation and arranged for us to get the material in the story starting on Page 36. Wilbur has been with WAVE since it went on the air in 1933—and he has long been a member of the BFASC Club.

*As We Were
Saying*

BFASC, for those who don't know, means best-friend-and-severest critic. This club, which is very unofficial, and doesn't even have a membership roll, is made up of station engineers who, over the years, have purchased our equipment. Having so qualified as our friends (and how better) they become, by the rules of the club, entitled to criticize, ad infinitum. And they do! Happily, most of this consists of suggestions for modifications, improvements, new features—that can be incorporated in upcoming models. More often than not these suggestions are based on day-to-day operating requirements which the design engineer—working in an isolated laboratory—may not fully appreciate. Thus the feedback from the BFASC helps keep our product line close to field requirements. So, believe it or not, we like the SC as well as the BF.

STATUS SYMBOL of the sixties in the studios is the TK-60. While the engineers still argue the relative merits of 4½-inch versus 3-inch—and whether it takes more light or less, and where the controls should be, and so on far into the night—the sponsors have made up their minds. Nowadays when a studio production picture appears in *ADVERTISING AGE*, *PRINTERS' INK*, or the other ad magazines, the camera shown is most likely to be TK-60.



Producers tell us that clients ask for it, and stars like to be photographed with it. Best of all, stations, agencies and reps are featuring it in their ads (see opposite page). And that doesn't make us mad at all.

Thinking about this happy turn of events, we said to ourselves, "We've got something good going here—let's push it." So that's why you will be seeing more ads like the Petry page for KMTV (see facing page).

And you will be seeing more and more TK-60's "in the flesh." Like the soaring sixties that the economists predicted, the TK-60 was a little slow getting going. But now both the economy and the TK-60 are rolling. Already there are more of these deluxe cameras in use in U.S. stations than any other 4½-inch I.O. camera. All the signs indicate that the TK-60 will be as preeminent in the sixties as the TK-11 was in the fifties.

RCA GOES TO THE FAIR will be the feature story in the next issue of *BROADCAST NEWS*. The RCA Exhibit Building (see above), containing an elaborately equipped color TV studio, has been designated the Official World's Fair TV Communications Center. From this studio (and an RCA mobile unit) color TV programs will be fed by a closed-circuit network to color receivers located in other exhibits, restaurants, lounges and public areas throughout the Fair grounds.

The equipment in this World's Fair Studio will be an engineer's dream come true. And, although it will hardly be an arrangement that you will go home and copy, still there will be some ideas worth considering. You will want to see it in person. But for your advance information we'll present a complete preview in our next issue.

FOOD FOR THOUGHT department. It's just possible your advertisers will expect to see in your studios the same, shiny, new equipment they will see at the Fair.

SEVEN FOR SEVEN is the new score for RCA-made satellites. TIROS VII was successfully launched on June 19, and programmed to supply photographs of weather conditions during the forthcoming hurricane season. It joins Tيروس VI which is still operating (see Page 10), on "weather watch for the world."

the announcer is 17 ...



... the crew is too. They're part of the Junior Achievement group of high school students who write, produce, direct, star in and sell their own programs on KMTV. These programs are a Junior Achievement first for Omaha. They are typical of the imaginative local presentations which help make KMTV first choice with viewers and advertisers.

Achievements of all KMTV programs are listed in the current ARB.* For example, ARB's Spot Buying Guide shows KMTV has more top-rated availabilities than the other Omaha stations combined.

For greater achievements in Omaha, see Petry about KMTV!

*Jan. '63

Reproduced by courtesy of KMTV
Omaha, Nebraska

...the Camera, the TK-60!

You'd expect it to be! Wherever TV achievement and youthful imagination are highlighted, this deluxe new RCA camera is pretty sure to be at the scene.



The Most Trusted Name in Television



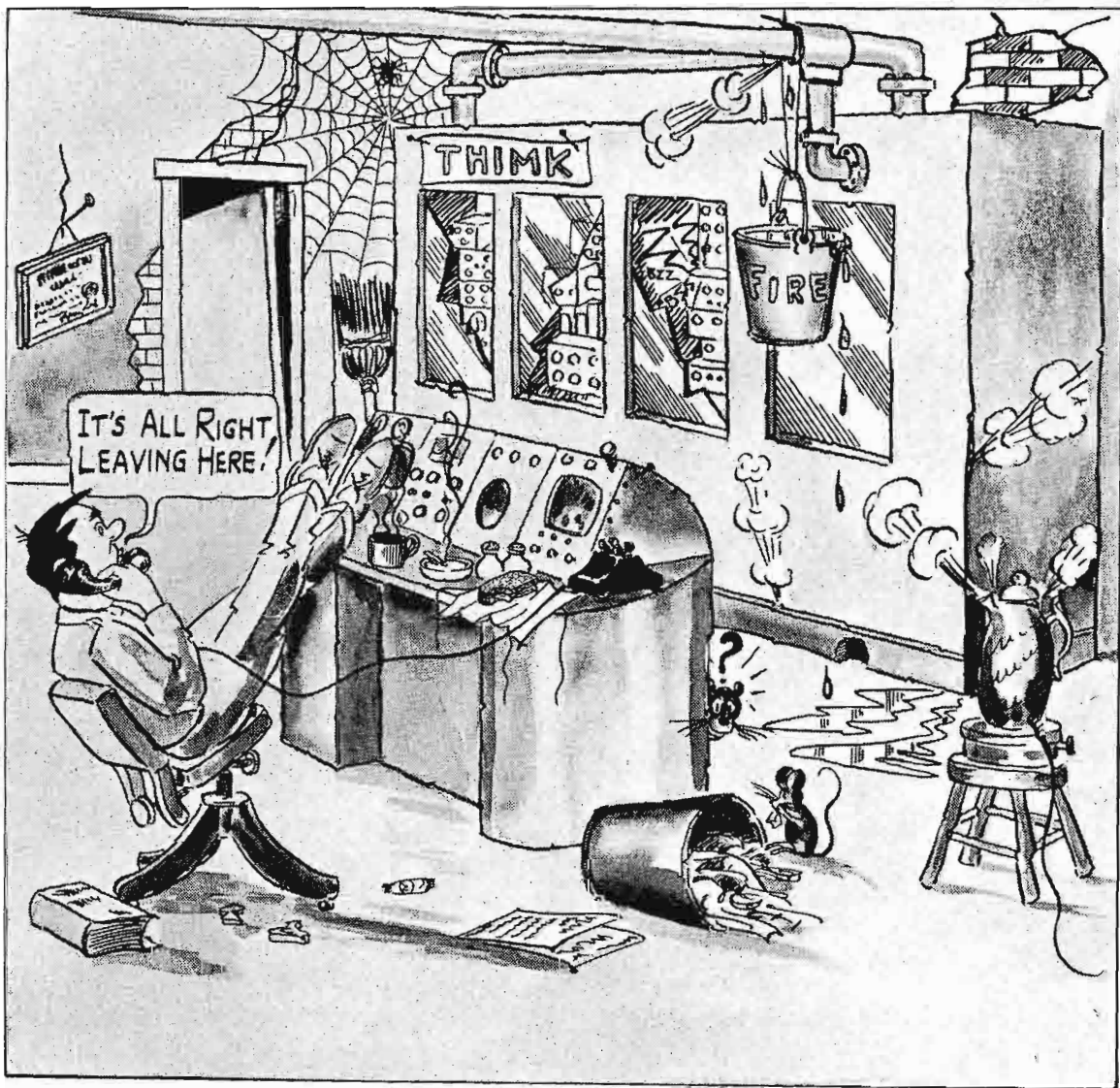

Forrest Griswold

IT'S ALL RIGHT LEAVING HERE is the theme song of a series of color seminars our engineers have been conducting during June at locations throughout the country. The purpose of these seminars is to bring station engineers up-to-date on color transmission technology and to provide them with detailed information on how get—and keep—a good color signal on the air.

As We Were Saying

Curiously, the idea for these seminars came from the receiver people. What happened is that as color receiver sales became increasingly important to dealers, there were more and more complaints from these dealers about the quality and/or consistency of color transmission in some areas. Usually the stations involved attached the blame to the network, to the telephone lines, or to "tape." However, further investigation sometimes located the fault in the local loop, in the station's microwave or terminal equipment and sometimes in the transmitter itself. And, of course, more often than not the trouble was a successive quality loss from step to step in the long chain from network studio to home receiver. But no matter where the fault, one thing was always the same. Invariably the word down the line was, "It's all right leaving here."

In the early days of color this situation was mildly humorous. And the story of the blue bananas still gets a laugh. But with the money that's riding on color today, it's no longer very funny.

SO WHAT TO DO about it. RCA and NBC engineers have investigated most of the reports of poor color that have been received during the

past year. Some of these proved to be due to sloppy operating or lack of proper maintenance. But—somewhat surprisingly—they concluded that much of the trouble, particularly the pyramiding kind, resulted from a widespread lack of knowledge as to how to properly monitor color pictures, what kind of quality to expect from the network, and how to handle the color signal through the station.

The color seminars we have been conducting are planned as a first-step answer to this situation. They begin with a presentation of what the network puts on the line—especially the test signals—and how they can be used. Following are three papers on the handling of the color signal in the station: first in the terminal equipment, second in the microwave link, and third in the transmitter.

We're under no illusion that these seminars will, in themselves, solve all of the problems. Nor even that they provide all the needed information. We do hope they will spur station engineers into making themselves more expert in this area.

WE WILL PRINT the papers presented at the seminars. The material was very detailed, with numerous slides to illustrate the narratives. Many engineers attending the seminars asked for reprints. We promised them this. And, since we think most station engineers will be interested, we plan to serialize the material in **BROADCAST NEWS**. The first part will appear in the next issue. We think it will be some of the most useful information we have presented in a long time.

HONEST INJUN, FELLOWS, we didn't mean to blur, or slur UHF. What we meant was that the optical horizon in the cover picture (last issue) was a little blurred (i.e., not well defined) just as (like) the elevation "horizon" that more or less determines UHF coverage is not sharply delineated. In fact we first wrote it about that way. However, in editing it down we perhaps went too far—and left a possible ambiguity. Certainly the amount of space we devoted to UHF—and the very careful (and we think very fine) treatment accorded UHF in the lead article by Mr. Peterson—should leave no doubts as to our true feeling.

WSBT-TV's chief engineer, Scott Hagenau, also takes us to task for saying "WBRE-TV's . . . record also includes the first RCA 1KW UHF." He claims WSBT-TV was first and quotes **BROADCAST NEWS** to prove it. That's a hard authority to argue with, and the book seems to back him up. **BROADCAST NEWS** Volume 73 (March-April 1953) carries stories on WSBT-TV, WSBA-TV and WFPG-TV, indicating that all of them went on the air with RCA 1KW UHF's on December 21, 1952. WBRE-TV, according to the same issue, didn't make it until December 28, 1952. Okay, Scott?

—The Armchair Engineer

What Station Men are saying about THE RCA "TRAVELING WAVE" ANTENNA

**At WMTW-TV, Poland Springs, Me.
Parker Vincent, Chief Engineer, says:**
"We decided on our Travelling Wave TV Antenna for the specific purpose of operation under the severe icing conditions we encounter on Mt. Washington (N.H.). We could not operate without it. Aside from the special properties of strength and ability to operate within a radome, the field of the antenna is very uniform."

**At KROC-TV, Rochester, Minn.
Robert W. Cross, Chief Engineer, says:**
"During installation and erection of our Travelling Wave Antenna, I was most favorably impressed with the mechanical simplicity and ease of assembly. Subsequent electrical check-out of the antenna and its 1300-ft. transmission line proved it to have the lowest VSWR of any system encountered."

**At KTSM-TV, El Paso, Texas
Karl O. Wyler, President, says:**
"I believe that KTSM-TV was one of the first stations to order the RCA Travelling Wave Antenna. It has been in service on Range Peak since December 1959, and we are completely pleased with its performance. We like it because there is practically no maintenance, no bolts to tighten, and fewer inspections. Overall efficiency is very good."

**At WLOS-TV, Asheville, Greenville, Spartansburg
Mitchell Wolfson, President, says:**
"WLOS-TV is extremely well satisfied with the Travelling Wave Antenna installation. Physical and electrical advantages met every promise and the increased signal strength throughout the station's 82-county, 6 state area exceeded all expectations."

**At KGIN-TV, Grand Island, Nebraska
D. Raymond Taylor, Chief Engineer, says:**
"Field strength measurements show that the signal far exceeds the predictions of the FCC 50/50 Field Strength Curve. Reports from viewers on the fringe area substantiate these measurements. The standing wave ratio is very good and no ghosting is present."

**At KOAM-TV, Pittsburg, Kansas
Leo S. Stafford, Chief Engineer, says:**
"I have viewed KOAM-TV from some 85 miles away and was amazed at the picture quality. The antenna has increased our area coverage by 63 percent, while at the same time it gives us 316 ERP on less transmitter power. This reduces primary power requirements and increases tube life."

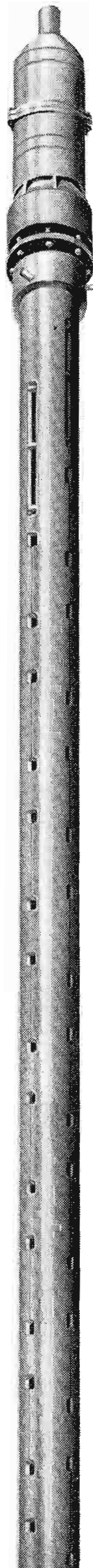

Favorite Antenna of High-Band Stations!						
CH 7	CH 8	CH 9	CH 10	CH 11	CH 12	CH 13
CJAY	KGHL	KLRN	KROC	CHCH	KCND	CKCO
KCMT	KSWS	KTSM	KXTV	KCBD	KEYC	KMSO
KOAM	WKBT	WAFB	WCBB	KGIN	KFVS	KOVR
WNAC	WMTW	WWTW	WIS	WBAL	KNMT	KSOO
WPBN	WOOD		WLBN	WLWA	KTVH	WGAN
WTRF	WQAD		WPTT		KVAR	WIBW
WXYZ	WXGA				WEAT	WJZ
					WMEB	WLOS
					WPRO	WOKR

If you want more facts about this VHF High-Band Antenna, your RCA Broadcast Representative can help you. Or write RCA Broadcast and Television Equipment, Building 15-5, Camden, New Jersey.



The Most Trusted Name in Television

RCA TV IN DIEBOLD VUE-MATIC DRIVE-IN BANKING SYSTEM

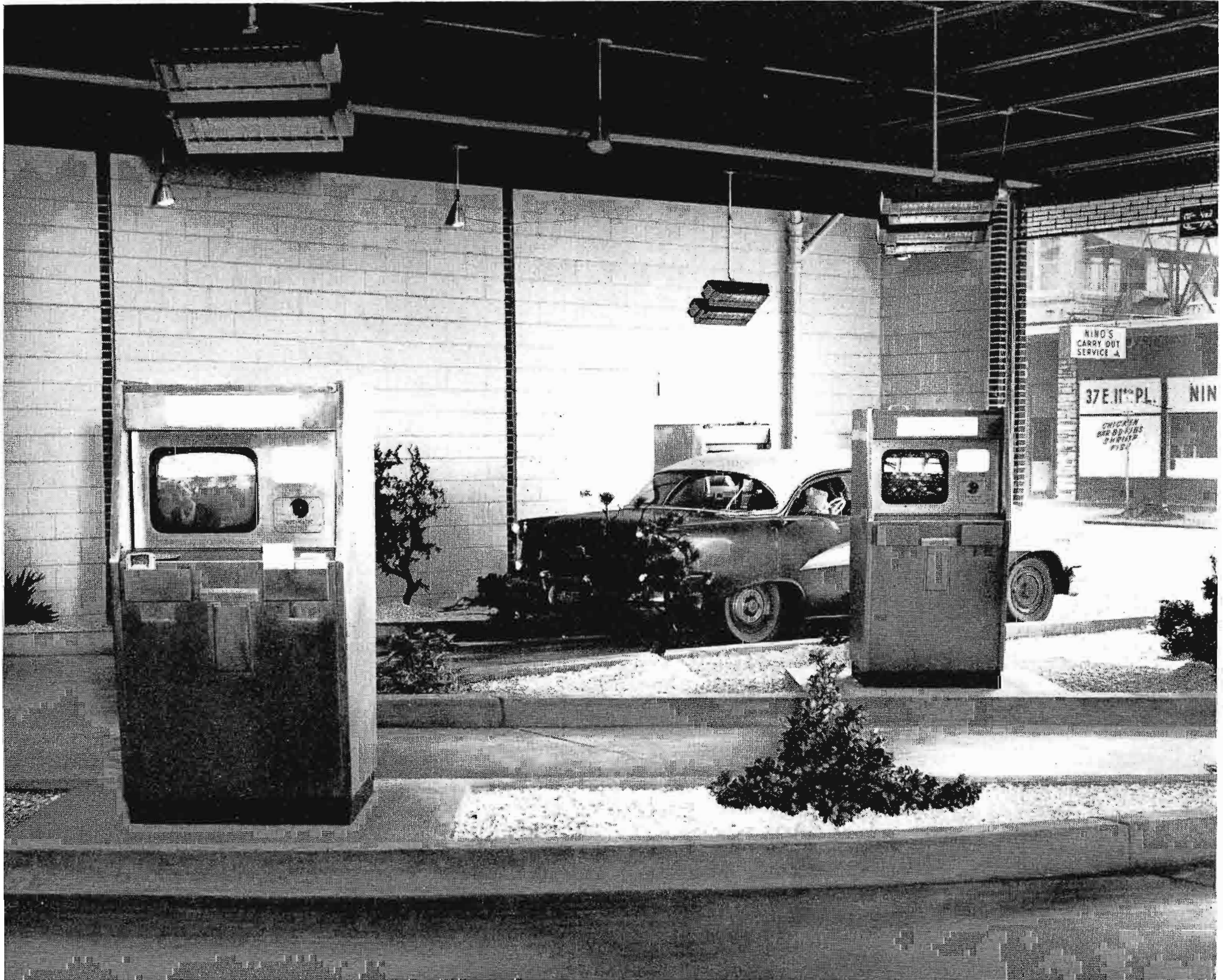

Among the first Vue-Matic installations is this three-position drive-up station at the Union National Bank in Chicago. Tellers can handle virtually any kind of banking transaction since they have access to central banking records inside the building. Overhead heaters warm customers when outdoor temperature drops.

Diebold, Inc., is using RCA's TK-202 closed circuit TV camera in a new drive-in banking system that provides two-way "hear and see" communications between a bank customer and a teller, each at separate locations. The Canton, Ohio, banking and office equipment firm has contracted for 250 cameras, the largest single order ever received for this type of equipment.

The system's television link permits the

drive-in teller to work within the bank's main business area and the customer's station to be located at a distance from the bank building. Currency, bankbooks and other items are exchanged at high speed via a pneumatic tube.

With conventional drive-in facilities, the teller mans a self-sufficient station, usually an extension of the bank building, to which the customer drives to transact his

business. Television communications retain this face-to-face relationship by electronic means and, at the same time, provide a high degree of flexibility in the location of physical facilities.

Since the customer station contains within its stainless steel skin all of the transfer and communications equipment needed for drive-in service, it may be located apart from the bank building—as

far as 500 feet away. Some banks have installed the outdoor unit in a corner of their parking lot, protecting it from the weather with a simple shelter.

The system also yields an important security advantage since the teller is located within the central banking area and no separate and external currency supply is required.

The Diebold Vue-Matic banking system consists of a customer station and a teller console, each containing a camera and a TV monitor. The system is so designed that the bank customer, upon arriving at the drive-in station, sees himself on the TV screen. By pressing a signal bar, the customer summons the teller who switches the "hear and see" system to two-way operation.

With TV communication established, the teller presses a button which gives the customer access to the system's "pneumatic courier" service. This whisks banking items between the two points at a rate of 25 feet per second.

The two-way communications system remains in operation while the transaction is completed and the banking items returned to the customer. The drive-in station camera is then switched back to the "see yourself" mode to await the next customer. At Vue-Matic installations, the "see yourself on TV" feature has proven to be a prime entertainment attraction, particularly for children accompanying a parent to the bank.

The T'K-202 cameras used at outdoor locations include automatic sensitivity control to maintain a uniform camera signal over a wide range of lighting conditions.

Diagram (below) illustrates how closed circuit TV and pneumatic tube link drive-in location to bank.



Inside Union National Bank, three tellers handle drive-in business quickly via "pneumatic courier" tube.



Electronic tete-a-tete takes place at drive-in station as customer prepares to make a deposit.



Close-up of teller position shows clear image of drive-in customer as it appears on 17-inch screen.

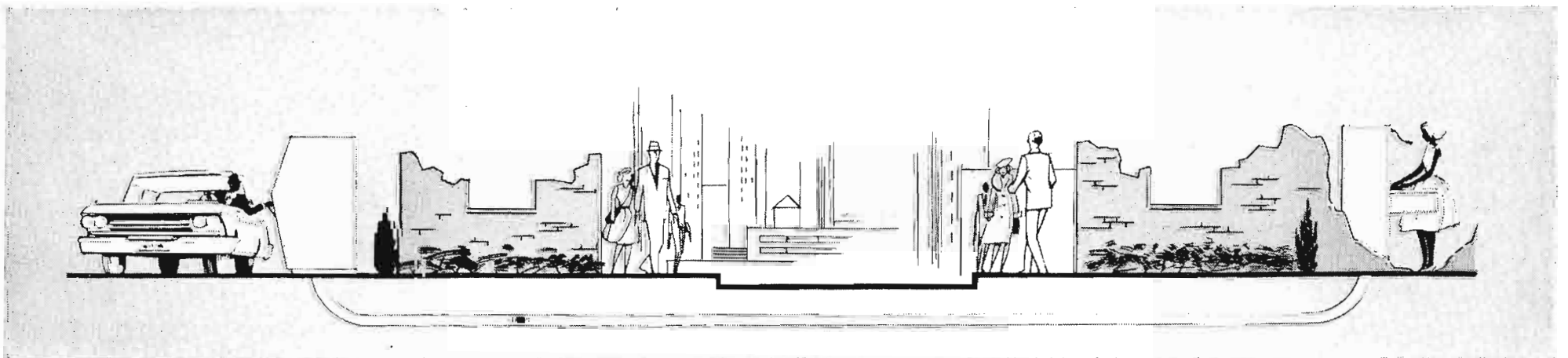

AIR SYSTEMS COMMAND USING COLOR TV AS MANAGEMENT TOOL

The Armed Forces are counted among the innovators in the use of television. Military men have been quick to grasp TV's potential, and to make the most of it for both tactical and non-tactical applications.

A current and striking illustration is the Air Force System Command's decision to use closed circuit TV—in full color—as a management reporting and communications tool. In doing so, its objective is to expedite the administration of some of the nation's most vital weapons systems which fall within the AFSC's responsibility.

Recently the Command began operation of its third color TV installation and, according to Lieut. Col. Maynard Y. Binge, Chief of its Command Management Center, is building a closed circuit network

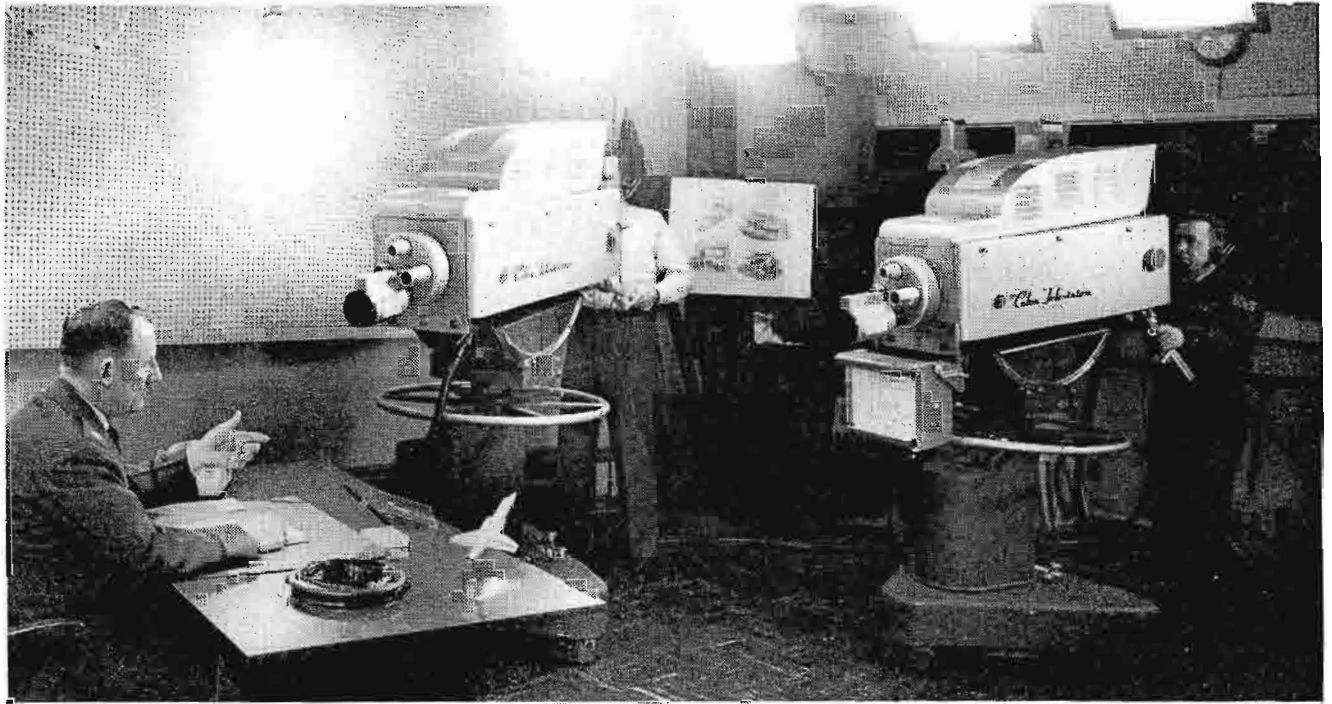

Two RCA TK-41C color cameras are trained on lecturer in taping session at Andrews Air Force Base.



Air Force staff group in briefing room views televised report on a Command project at distant base.



Andrews AFB video tape recording facilities include RCA TRT-1B and a transistorized TR-22 shown here.

that ultimately will link nine of its divisions and centers with AFSC Headquarters at Andrews Air Force Base in Maryland.

Color television equipment, which was supplied by the RCA Broadcast and Communications Products Division, includes, at each location, two TK-41C color TV cameras, a TK-26 color film chain, a TRT-1B TV tape recorder with color rack and a full range of control and switching gear. The Andrews AFB installation also includes a transistorized TR-22 TV tape recorder.

Colonel Binge said the AFSC chose color facilities rather than black-and-white on the basis of many TV industry studies and other evidence that programs in color have at least three times greater impression value than those in monochrome. "In an age of aerospace technology and weapons systems, where men must absorb and remember an ever-increasing amount of information, we need the most effective management tools available, and color TV certainly is among them," he commented.

Closed circuit equipment is now in operation at Andrews AFB, at the Space Systems Division in Inglewood, Calif., and at the Air Force Missile Test Center at Patrick AF Base near Cape Canaveral, Fla. For the present it is used chiefly to tape record briefings and status reports on key weapons systems under AFSC control. Thus a full-dress briefing, complete with charts, graphs and even some military "hardware" items, can be presented before TV cameras on the West Coast and tape-recorded

in full color. Tapes are air shipped overnight to AFSC Headquarters for viewing and evaluation the next morning. This makes it possible for General Bernard A. Schriever, AFSC Commander, and his staff to see and hear a detailed, up-to-the-minute status report on a Command problem, and sets the stage for a prompt decision.

Besides creating a stronger impression, color gives the TV briefer more flexibility in his presentation and helps to keep interest high during long or complicated briefings. Television reports on tape also permit engineering and other skilled personnel at distant locations to remain on the job, thereby saving the time and money required to transport them and their materials to the briefing audience.

On some occasions, one officer may accompany the tape to answer questions that arise during playback and to provide additional information. On others, a "secure" telephone circuit may connect headquarters and the field installation while the briefing is on the screen. Another advantage of a briefing on tape is the availability of the tape for repeat playbacks at a time convenient to key staff officers and others not able to witness the first presentation.

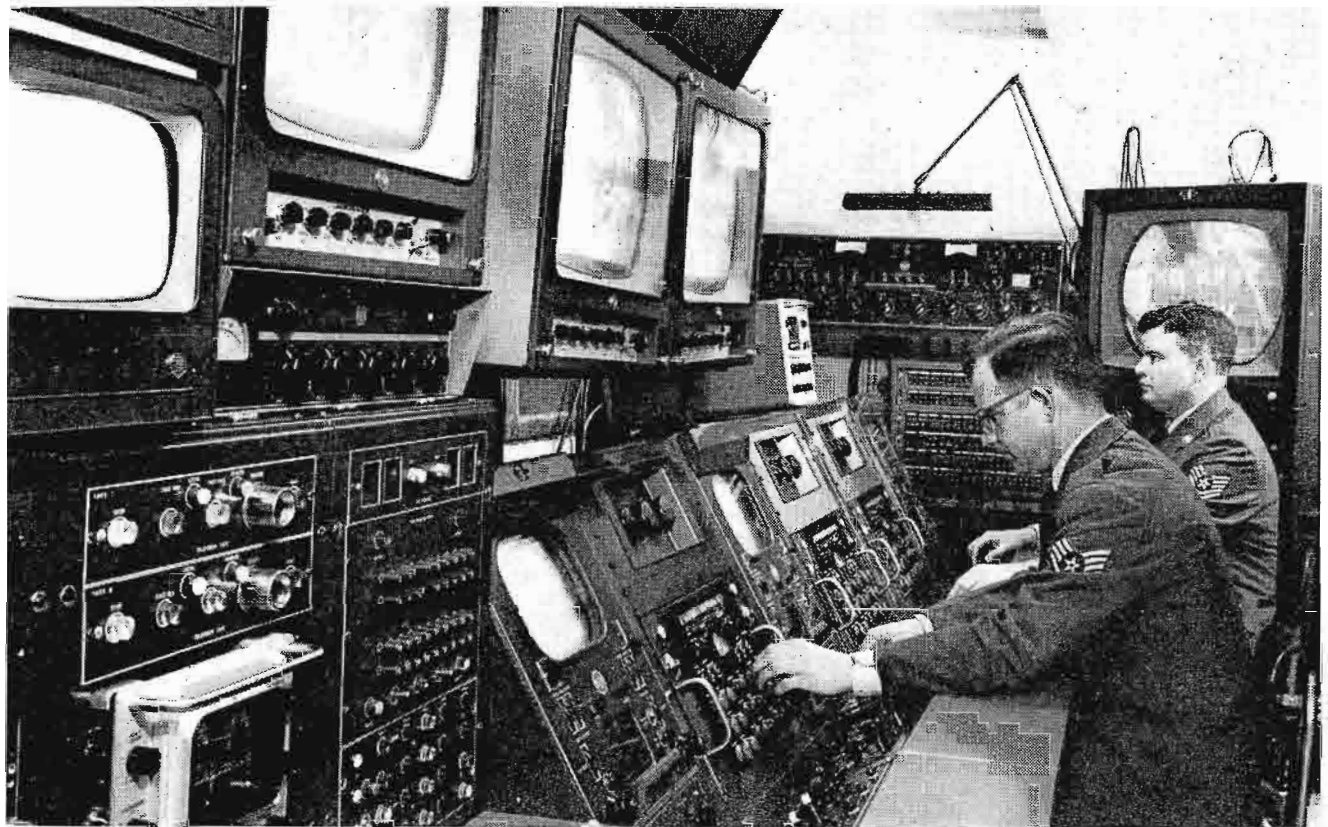

Control room scene shows array of professional switching and other gear used in Andrews' CCTV system.

At some future time, AFSC plans to operate its closed-circuit network on a "real time" basis which, in military terminology, means the ability to communicate about events as they occur. Thus, most AFSC locations would be connected by secure video and audio links and participants in

a "live" conference would be able to hear and see each other. AFSC also expects to obtain mobile TV equipment for the Air Force Missile Test Center so that cameras can roll to vantage points near the launch area and cover missile shots on both a "live" and tape-recorded basis.

EUROPEANS WATCHED IT 'LIVE' VIA RELAY SATELLITE



TV monitor photograph of White House garden ceremony honoring Sir Winston Churchill was made from NBC-TV's coverage which was bounced off Relay satellite. Signal also went to Europe via Relay.

Millions of viewers in Europe and North America watched "live" television coverage April 9 as President Kennedy conferred honorary U.S. citizenship on Sir Winston Churchill. The British leader himself was at a TV set in London as pictures of the ceremony were carried abroad via the Relay satellite, built by RCA for the National Aeronautics and Space Agency.

The 3 p.m. White House ceremony had been rescheduled from 4:30 p.m. to coincide with a relatively short period of mutual visibility on Relay's 910th revolution. TV signals were sent by conventional video circuits to the A.T. & T. ground station at Andover, Maine, and thence to the satellite some 4,000 miles in space. Relay passed the signals onward to a ground station in England where the program was fed to networks there and on the Continent. This marked the first time an Iron Curtain country had accepted a U.S. TV program beamed by satellite. Since Relay was launched December 13 it has been used for more than 500 scientific experiments and demonstrations.

NEW TIROS MAY 'WHEEL' IN SPACE

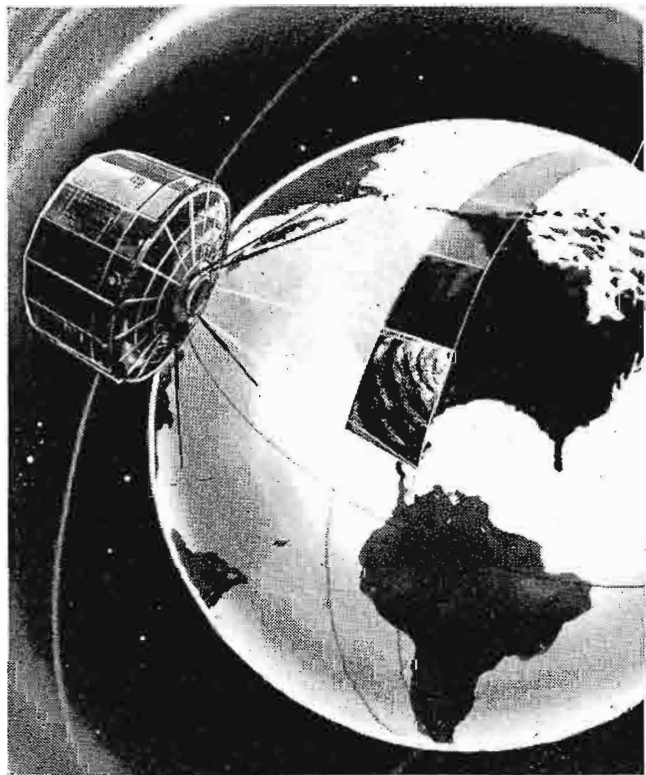

A new concept in the design of the famed TIROS "weather eye" satellite, to provide continuous picture-taking of the earth and its cloud cover, will be developed by RCA under a study contract from the National Aeronautics and Space Administration. The

new TIROS would employ a "wheel configuration" design. In effect, the present hatbox-shaped satellite would be turned on its side and made to roll endlessly through the sky, snapping pictures of the earth. It would be launched in a polar orbit, meaning that every area of the world would be photographed at least once a day.

Its two TV cameras, instead of looking downward through the flat base-plate as presently (parallel to the spin axis), would be located sideways on the base-plate, looking outward from the rim in opposite directions (thus being at right-angles to the spin axis).

As the satellite rolls along its orbit, at 12 revolutions per minute, its cameras would take a picture of the earth below every three seconds, the intervals being spaced to avoid excessive overlap of the photographs. Each picture would be stored on magnetic tape, to be read out on command when the satellite came within range of a ground station. Pictures taken within range of the ground installation could be read out immediately.

The new TIROS would use the same type of wide-angle camera as earlier TIROS satellites. This employs a half-inch vidicon tube, enabling the camera to photograph 500,000 square miles of the earth's surface with each picture.

The advantage of the wheel-design is that it permits the television cameras to look earthward throughout its orbit. The present TIROS satellites can "see" the earth only about one-fourth of the time because the spacecraft cannot keep its base facing toward earth. As it orbits the earth, its position remains constant and eventually the cameras lose ground contact and stare into space.

With the launching of TIROS VII on June 19, NASA's record was seven weather satellites orbited in seven tries. Since April 1, 1960, when the series began, the RCA-built satellites have sent back more than 230,000 pictures of cloud cover, snow and ice conditions, storms and other meteorological data. TIROS VI, launched last September, was still operational when we went to press. It was used for weather observations for both the Cooper and Schirra space flights in Mercury capsules.

BALLOON-BORNE EYE SCANS PLANET MARS

The huge balloon shown here soared to the edge of space last March 1, carrying a 36-inch telescope which was aimed at the planet Mars by a complex television pointing system on the ground. The unmanned flight produced TV pictures of Mars' infrared spectra which are being studied to determine if there is enough water on the planet to sustain life.

The remarkable ascension was carried out by Princeton University scientists at the National Center for Atmospheric Research at Palestine, Texas. The TV aiming system was designed and built at RCA's David Sarnoff Research Center. It was a second triumph for Princeton which in 1959 sent up the first balloon-borne telescope, also aimed by an RCA TV system, which resulted in excellent pictures of sun spots.

Two television cameras were used, both incorporating special image orthicons that are at least ten times as sensitive at low light levels as conventional I.O. tubes.



SOME FISH HAVE A TV CAMERA RIGHT IN THE LIVING ROOM



Wheelhouse control console brings in pickup from any of shipboard system's four television cameras.

The Albatross IV is a 187-foot vessel equipped for deep sea fishing, but her "catch" is more likely to be TV pictures than a mess of mackerel. This is not hard to fathom, for the \$2,000,000 ship is assigned to fisheries research by the federal government and uses underwater television for candid studies of life in fishdom.

The underwater camera, which is part of an RCA-supplied closed circuit TV sys-

tem aboard ship, helps scientists of the Bureau of Commercial Fisheries to develop information on fish behavior, abundance and distribution and on other matters of vital concern to the nation's commercial fishermen. Three other cameras, operated from fixed positions aboard the Albatross IV, provide visual communications and help to insure the safety of the ship's complement of 16 scientists and 22 officers and crew.

A unique feature of the system is a low power TV transmitter which is used to broadcast pictures produced by the cameras to portable receivers on the vessel's weather decks. The Monitran transmitter is controlled from a console in the ship's wheelhouse where the operator selects which of the cameras to put "on the air." The pictures also may be received on six wired-in video monitors, including one at the control console.

For underwater observation, the TV camera is encased in a special waterproof housing and mounted at the axle position of a wheel-like metal frame. The camera, with its cable connection to the ship, goes overboard inside a large trawling net. In earlier studies using television, government scientists have observed pictures from the towed net and its catch continuously for as long as three hours. A permanent pictorial record sometimes is made by photographing a monitor screen with a still

camera or with a motion picture camera modified to operate at the television scanning rate of 30 frames a second.

The television camera adapted for the Albatross IV's underwater probes is a standard RCA industrial type (TK-202) using a vidicon of high sensitivity. While the vidicon performs satisfactorily with a relatively low level of light, some underwater observations require more illumination. In such cases, a 1000-watt diver's lamp usually is used.

The system's three shipboard cameras are enclosed in weather-proof housings which are heated and cooled under thermostatic control to keep them operative under all types of weather conditions. A windshield wiper on the housing's glass face assures the camera lens a clear view in storms or sea spray. Two of the cameras are positioned high on the ship's masts and cover fore and aft decks. One of them is trained on the remotely-controlled main winch, enabling the winch operator to make certain the area is free of ship's personnel before the winch is started. The aft camera, which can be panned and tilted remotely from the wheelhouse, overlooks the fishing deck, allowing the officer on the bridge to keep track of operations there without leaving his station. The system's third camera is trained forward, giving those in the after part of the ship a view from the bow.

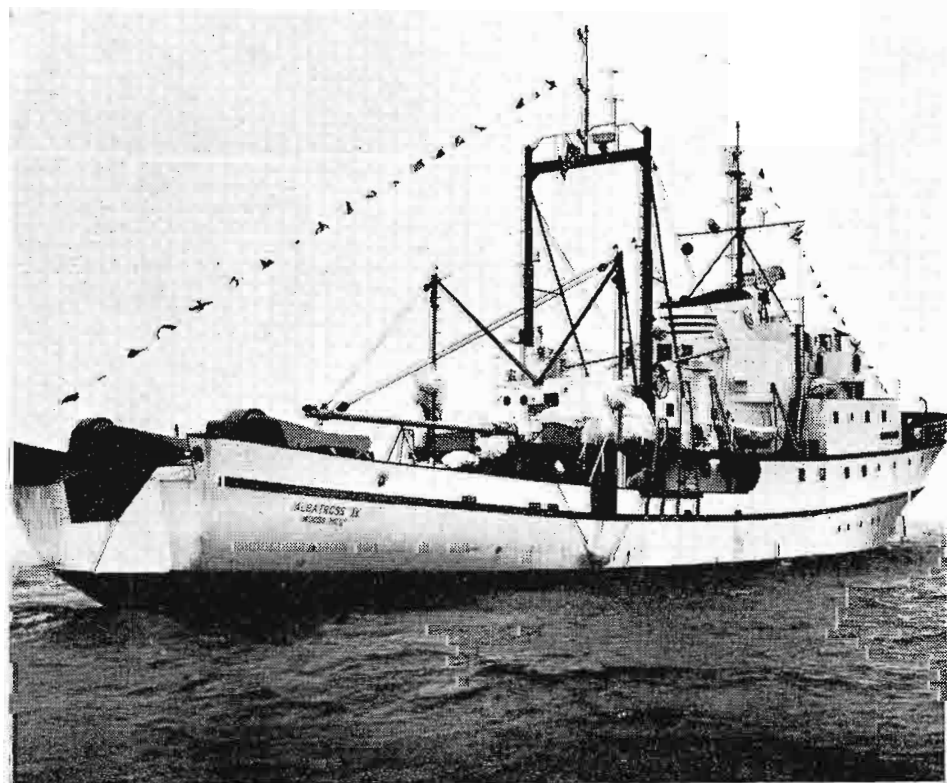

This view of Albatross IV shows two TV cameras in weatherproof housings on crossarms of research vessel's fore and aft masts.



Better than a home fishtank is this TV monitor view of haddock family caught by underwater camera as it swims in the Atlantic.

INSTRUCTIONAL TELEVISION AT THE UNIVERSITY OF AKRON

Features Talk-Back Circuits, Instantaneous
Reporting of Student Response
and Computer Calculation of Grades

by K. F. SIBILA, *Head, Department of Electrical Engineering*
and W. MAVRIDES, *Director of Television*

After months of study, including visits to other Instructional Television centers by faculty members, the University of Akron, on May 19, 1960, announced its intention to enter the field of education through television. This decision was made to help solve, in part, the problem of securing enough qualified instructors to adequately handle the constantly increasing number of students enrolling at the university.

On May 31 the Fund for the Advancement of Education provided a grant to be used for the released time of two faculty members in order that they might carefully prepare to teach courses through educational television for a period of three years. Involved were three required introductory courses: Two in "Effective Speaking" and one in "Reasoning and Understanding in Science."

Additional money for the operation was made available from special funds and did not come from tax monies or student fees. An initial investment of \$64,283 purchased production, transmission, distribution, and reception equipment. The TV Center, including control room and studio, thanks to the foresight of the university administration, had been built into a new campus building (Kolbe Hall) approximately eight years before. This future Instructional Television Center functioned as an auxiliary radio studio and conference classroom until June, 1960, when orders were finally placed for equipment.

Equipment and Facilities

The major equipment items and supporting services include:

1. RCA dual TK-15 vidicon camera system with output amplifiers, power supplies, master monitors, lenses, camera cables, tripods, tripod dollies and other related items.
2. One RCA TK-21 vidicon film camera chain including multiplexer, two 16mm film projectors with pedestals, RCA TP-7 dual drum slide projector, automatic sensitivity and remote controls and related components.
3. One RCA TG-2 sync generator, TS-5 switcher-fader, TA-3 distribution amplifier, four TS-2 video switchers, equipment racks and other items such as three TM-41 monitrans and a Conrac VHF off-air tuner.



FIG. 1. Dr. Louis Ross teaching Algebra-Trigonometry to a freshman class. This is distributed among four classroom buildings. A University of Akron engineering student is operating the RCA TK-15 camera.

- An independent air-conditioning system was installed and designed in such a way that the existing blower system could be utilized. A single compressor and refrigerating unit was arranged so that it could efficiently accommodate both FM radio studios and the TV Center.

(This is a partial inventory but more detailed information follows.)

By January, 1961, the Instructional Television Center was operating eleven hours per week and offering five required large-enrollment General Studies credit courses to almost 1600 class registrants. In less than six months the University of Akron had developed the second largest application of the TV medium to instruction in the state of Ohio. During the Fall semester, 1962, almost 3600 class registrants were receiving all or part of nine required credit courses by TV, which involved a total of 20 hours of "live" television instruction per week.

Planning

It might be useful for those who are contemplating the use of television for instruction if procedures followed by the University of Akron are listed in order of importance, as well as occurrence:

- May, 1960: Decision announced by university officials to incorporate TV as a permanent part of its educational facilities.

Addition to the faculty of an academically qualified and professionally experienced Director of Television.

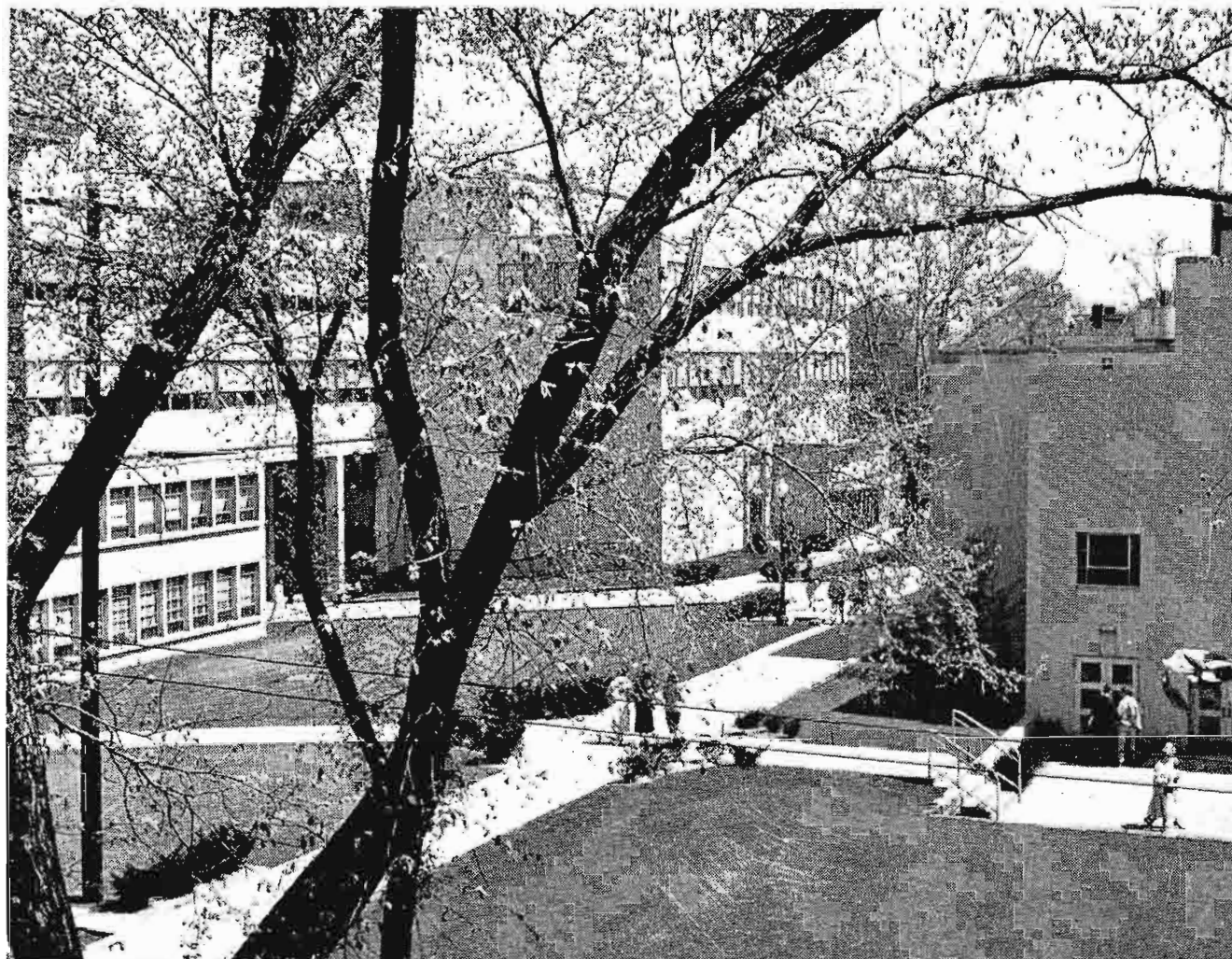

FIG. 2. Birds-eye view of the University of Akron's Kolbe Hall which houses the Instructional Television Center, WAUP-FM's studios, transmitter and antenna, the electronic language laboratory, and University Theatre.

- June, 1960: Responsibility and authority delegated to the Head of the Electrical Engineering Department for designing and installing the TV layout including production and distribution facilities, etc.
- June, 1960-January, 1961: TV instructors worked with Director of Television in preparation for the transition to instruction through television.
- September-December, 1960: Equipment began arriving and installation by engineering students, under close supervision of the Head of the Department of Electrical Engineering was begun. The Director of Television made recommendations in line with his particular programming-production needs. A full-time Technical Director was retained whose duties would include all preventive and operational maintenance of television equipment. He also (having a first-class F.C.C. Radio-Telephone Operator's license) would serve as Chief Operator of Akron University's proposed radio station, WAUP-FM (which began operating in December, 1962).
- December, 1960: A successful series of interview programs, originating in the TV Center, were "piped" by co-axial cable to the remote truck of a local commercial TV station (WAKR) for integration with their telecasts of campus-originated basketball games.
- January, 1961: Dedication activities, which included on campus closed-circuit TV demonstrations as well as production and presentation of a live one-hour program which was relayed from the TV Center, via telephone line, to WAKR-TV for telecasting to the Akron, Ohio, community.
- February, 1961: Formal instructional television began.

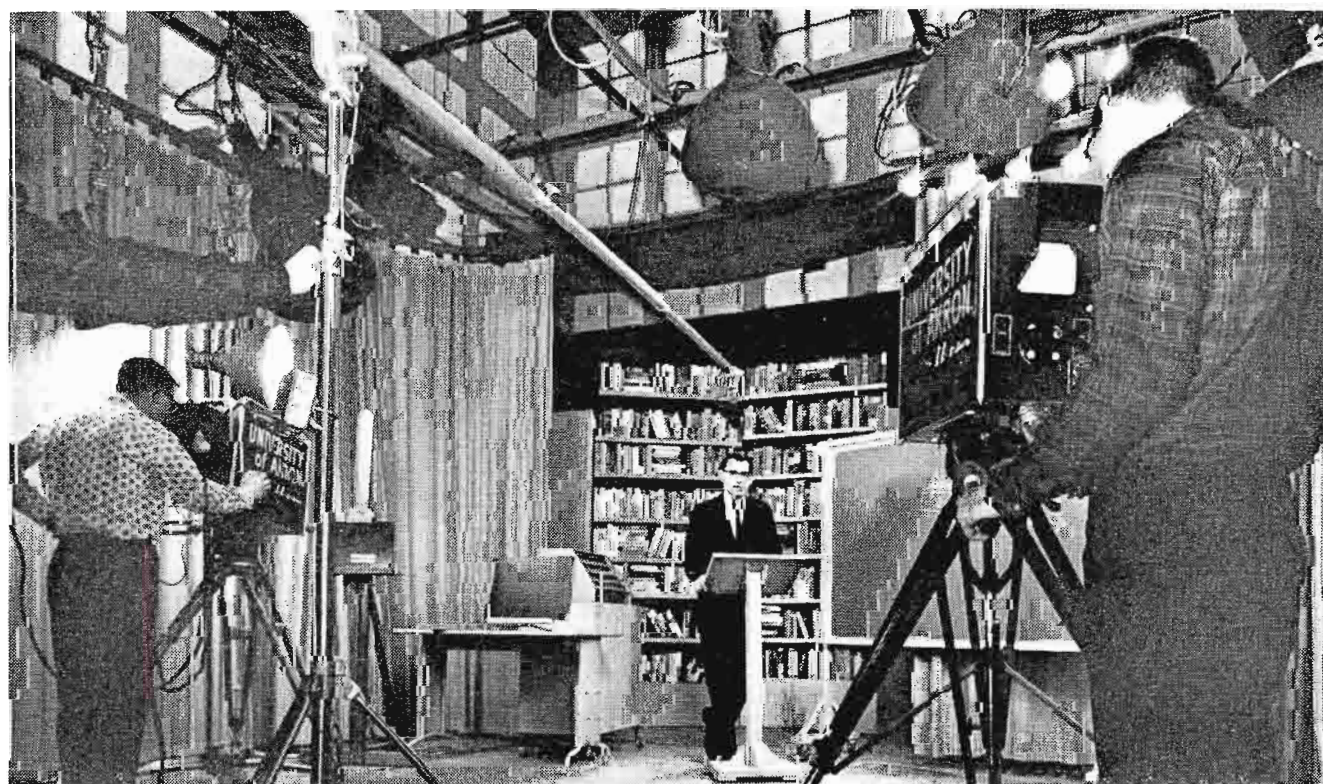

FIG. 3. Professor John Popplestone lecturing on Learning Theory to 800 General Psychology students distributed throughout four buildings and nine TV viewing classrooms. TK-15 cameras and microphone boom operated by University of Akron student employees.

General Construction

Construction on the closed-circuit television installation began in the empty control and studio rooms, the floor plans for which are shown in Fig. 4. This sketch shows the lighting grid, and air conditioning ducts.

Installation work of the entire project was completed by eight co-op electrical engineering students from the electrical engineering department of the university and two university electricians within a period of some six months. Approximately six to eight miles of coax and control cables were installed in campus steam-tunnels and buildings. Costs were considerably reduced by the use of co-op students.

Lighting Grid

Design and construction costs were further minimized by using conventional and readily available electrical equipment and parts in place of regular theatrical components. For instance, the lighting grid was clamped together with simple strap-type pipe hangers in place of more costly cast-iron theatrical clamps. Regular outdoor floodlight fixtures (costing \$19 each) were used in place of conventional studio scoops (which would have cost approximately \$45 each).

The pipe grid was suspended on $\frac{1}{4}$ -inch steel rods fastened to angle irons which

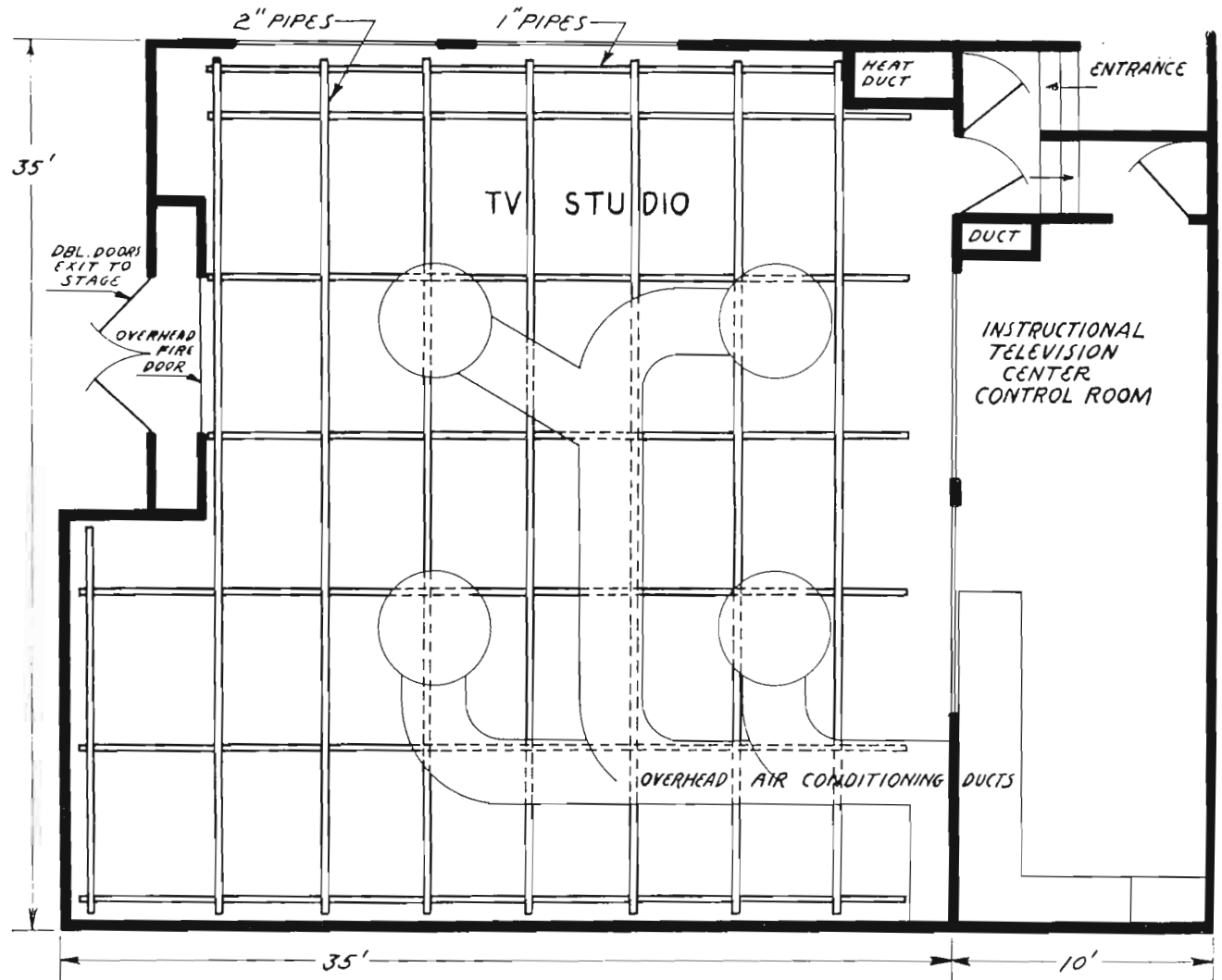

FIG. 4. Instructional television center floor plan. The stage doors open to the University of Akron's Theatre from which CCTV presentations are also originated. The overhead pipes form a grid for supporting studio lighting fixtures (see Fig. 5 below).

FIG. 5. Studio lighting grid arrangement. (Inset) Detail of special cross pipe clamp.

were bolted into the ceiling. The ceiling height is 21 feet. The pipe grid is 13 feet above the floor. Rectangular electrical duct was fastened to the steel rods just above the pipe grid. There are 22 electrical circuits in these ducts for lighting and all circuits are controlled by low-voltage relays. A special switching circuit makes it possible to control as many of the individual circuits from a single switch as is desired. Figure 5 shows the pipe grid with all lights.

Control Room

Extensive, and sometimes ingenious, planning became necessary to insure that all required equipment would fit into the unusually small control room in an orderly and efficient manner. This room had to house all racks, camera amplifiers, lighting control panel, power supplies, rf distribution equipment, camera monitors, switching console, audio console, complete film chain, turntables, film-editing area, talk-back relay racks, tube-tool storage space, and cable trench, see Fig 6.

Cost was also a determining factor in the design and fabrication of a simple angle-iron frame work, mounted on a table, which functions as an adequate substitute for more expensive commercially available switcher-fader and monitor cabinets. The University's engineering department machine-shop made this unit for a cost of approximately \$25. The four TM-35 monitors, controls for the film chain and the switcher-fader are located in this home-made mounting shown in Fig. 7.

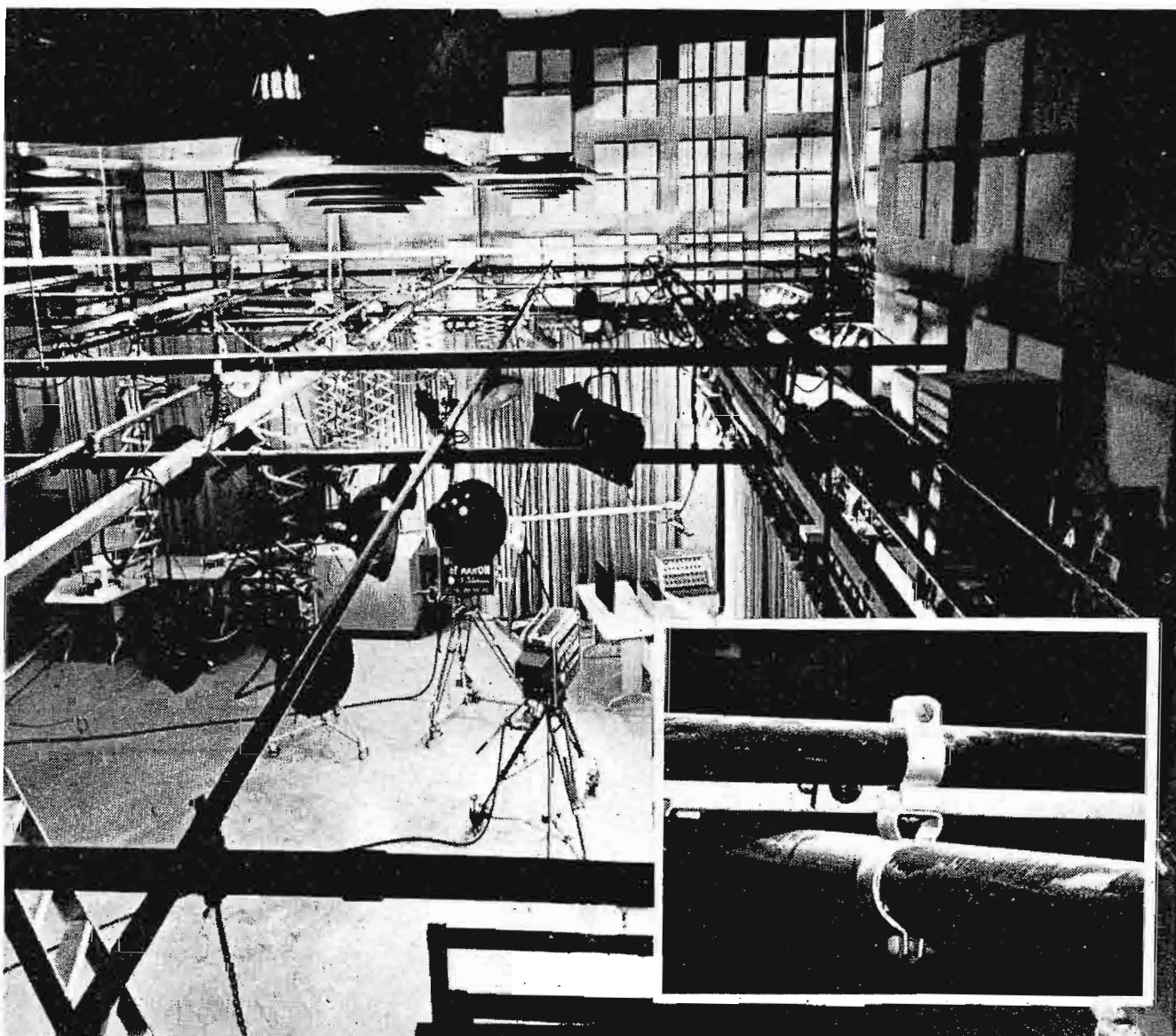

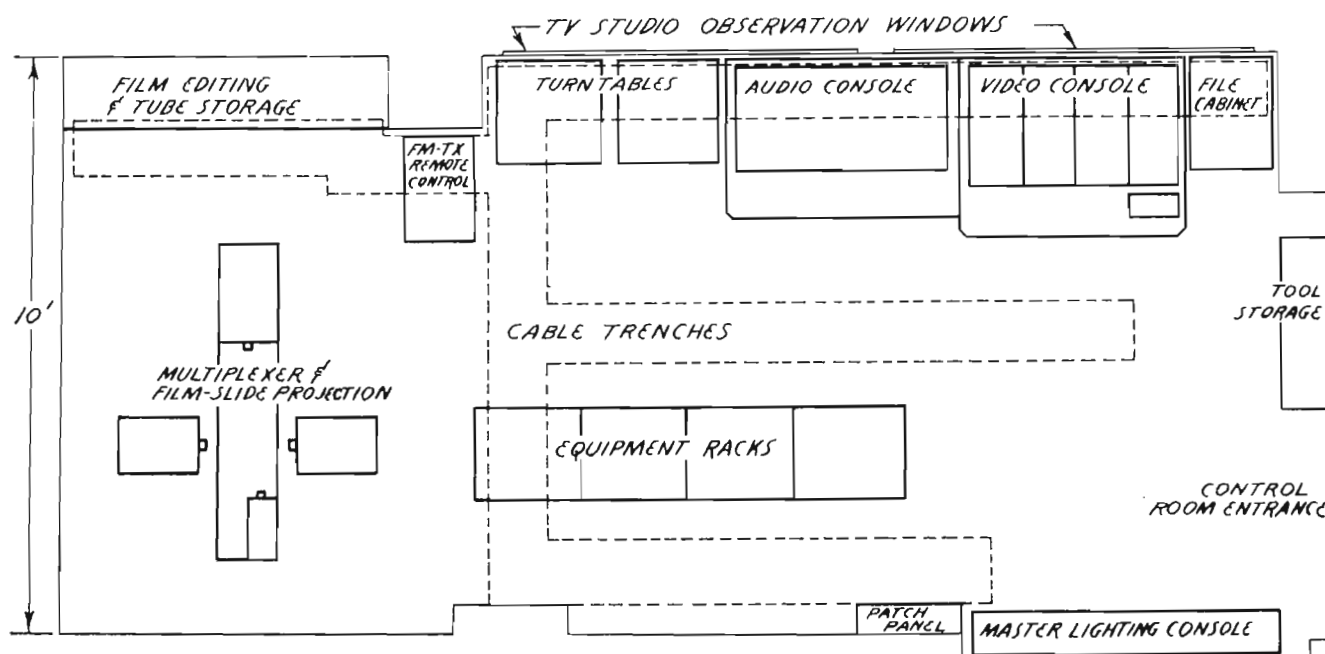

FIG. 6. TV control room layout.



FIG. 7. Video control center, showing four TM-35 master monitors, controls for film system, and switcher-fader.

Distribution Cables and Lines

With work in the studio and control rooms well under way, the work of installing coax cables, microphone and talk-back system control lines was begun. The campus layout is shown in Fig. 8. All lines between buildings were installed in service tunnels.

The main coax, RG11-U Poly-foam, runs the entire length of the campus, a distance of about 2000 ft. Two amplifiers are inserted in this line—one at Buchtel Hall and another in a building just west of the ROTC Bldg.—to maintain a level of rf signal of approximately 35 to 40 db

at the entrance point of each building (Zero db represents 1000 micro-volts into a 70 ohm load.) Figure 9 shows the method of cable distribution throughout a complete floor in a typical classroom building.

The cable system as installed is a multi-channel rf system having a utilization capability of nine separate channels (2, 3, 4, 5, 6, 7, 8, 9 and 10). Four of these are for off-air pick up of local commercial TV stations (3, 5, 8, and channel 49 converted to channel 4). Channels 6 and 10 were made available for conversion of MPATI channels 72 and 76. (To date an acceptable signal has not been received in this area from the MPATI airplane, which is 200 miles due west of Akron.)

Three channels (2, 7 and 9), are for on-campus simultaneous transmissions by local monitrans. The layout of the video and rf distribution, showing all inputs, interconnections, and line amplifiers, is shown in Fig. 10.

Talk-Back System

Another feature incorporated into the original TV installation is a "Talk-Back" arrangement. This permits students to ask questions directly of a TV instructor while lectures are in progress. Requirements which this system had to meet include: (1) The student should not have to leave his seat to ask a question; (2) No microphone should be passed around the room, and (3) All other rooms viewing the lecture should simultaneously hear the question.

With these stipulations in mind a circuit was developed using low-impedance microphones located near the front of each classroom. These microphones are connected into the audio circuit through relays, operated by the instructor from a studio console. This console contains panel lights—one for each TV viewing classroom—and a buzzer.

FIG. 8. University of Akron campus RF distribution cable.

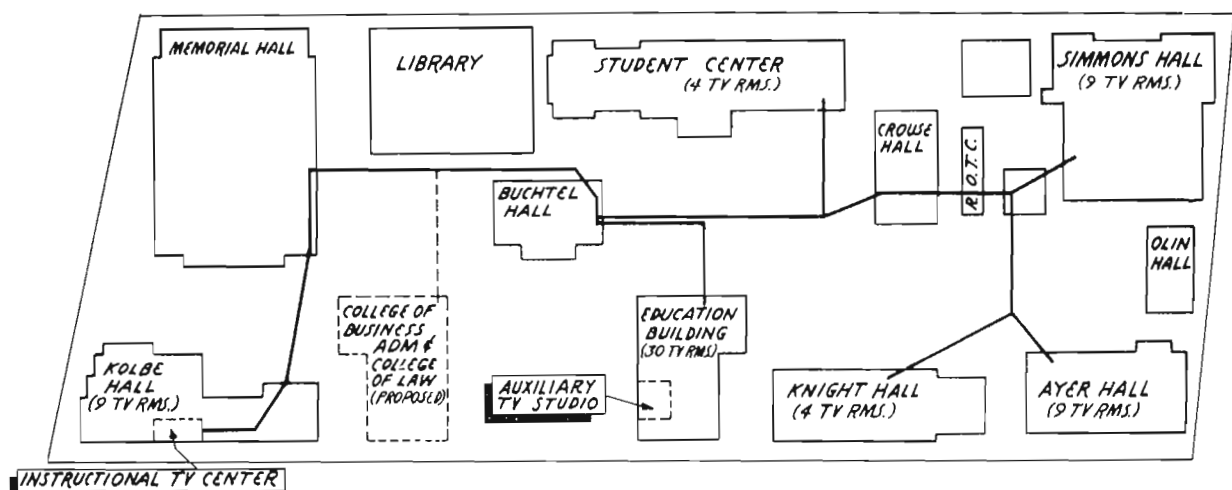

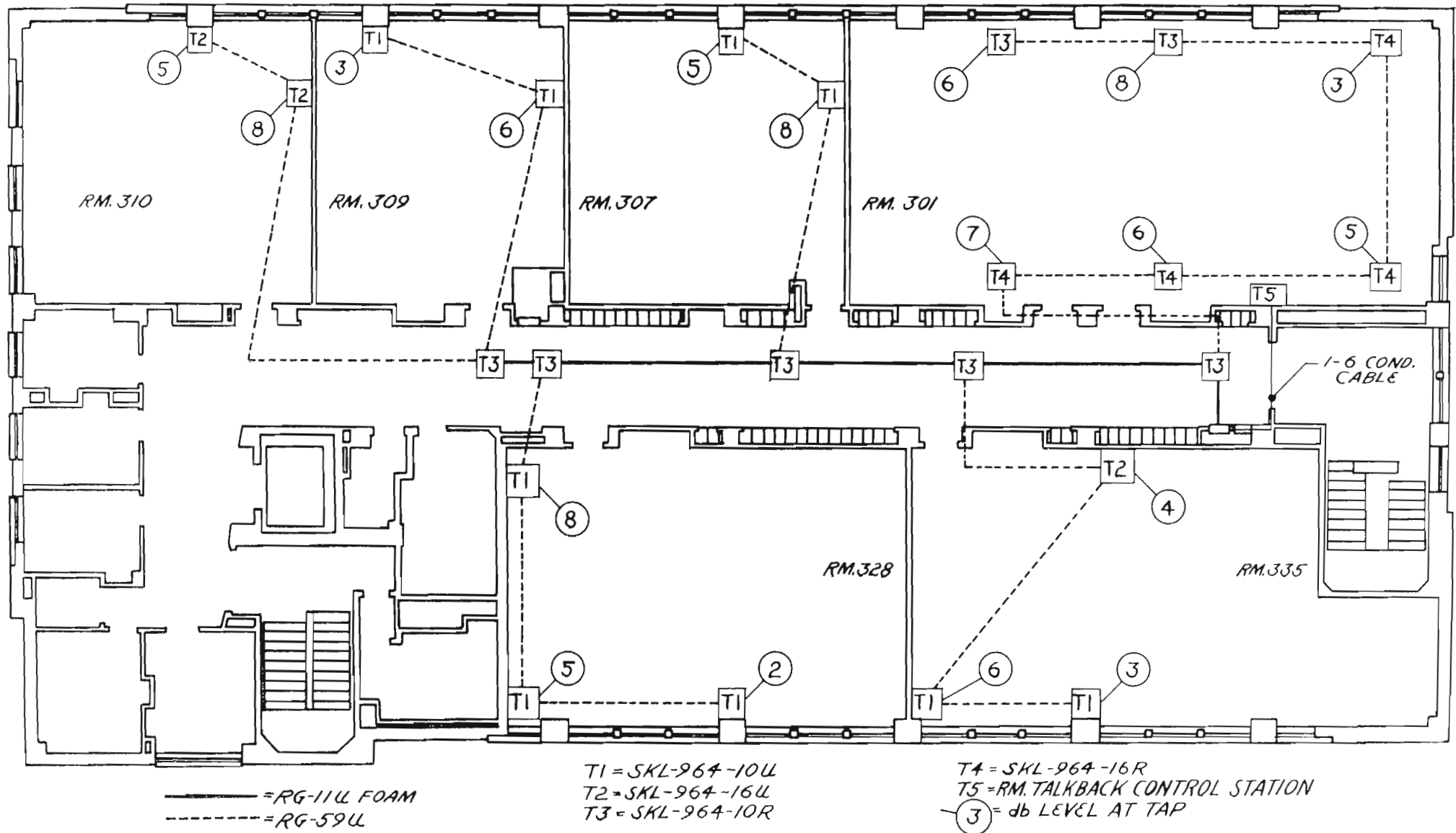
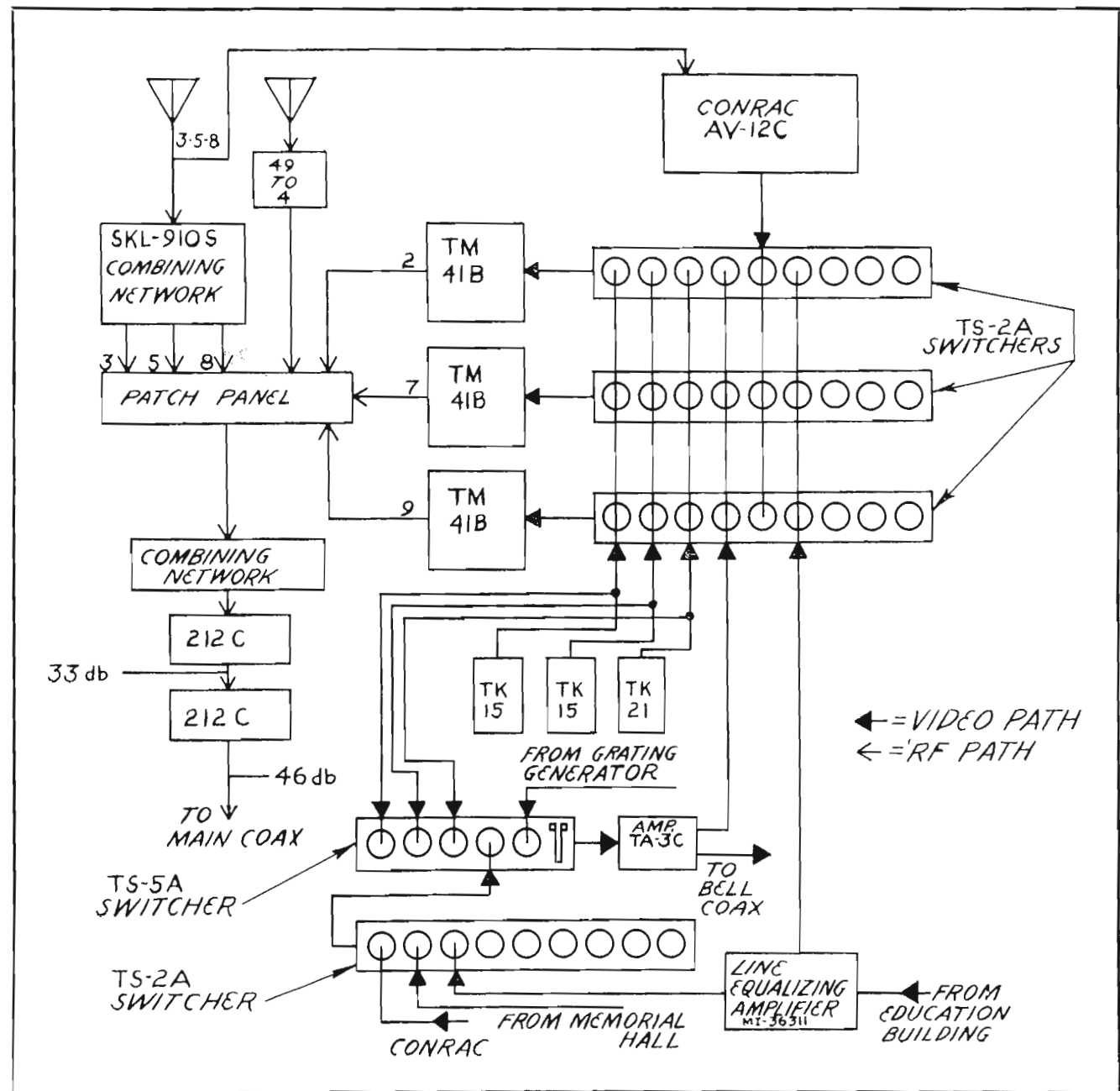

FIG. 9. Third floor plan of University of Akron's College of Education Building showing cable distribution.

FIG. 10. Interconnection of Video and RF distribution system.



When a student wishes to ask a question he so indicates to a proctor in his classroom. The proctor then presses a switch located near the front of the room. This switch operates the buzzer and a panel light corresponding to the specific room from which the question is originating.

When the instructor is ready for the question he so indicates and then depresses the switch on his console which corresponds to the classroom. This switch simultaneously, through relays, disconnects his mike, the speakers in the TV sets in the classroom, and connects the room mike into the audio circuit. The audio circuit is arranged so that the original question is heard both in the studio and in all viewing classrooms. No repetition of questions is therefore necessary.

A view of a typical classroom is shown in Fig. 11. Room microphones are either surface or flush-mounted. The TV instructor's studio Talk-Back console is shown in Fig. 12. Both surface and flush-mounted classroom control stations are used as shown in Fig. 13.

A Talk-Back control relay rack is located in Ayer Hall to accommodate Ayer, Knight, and Simmons Halls. Another is located in the Education Building and a

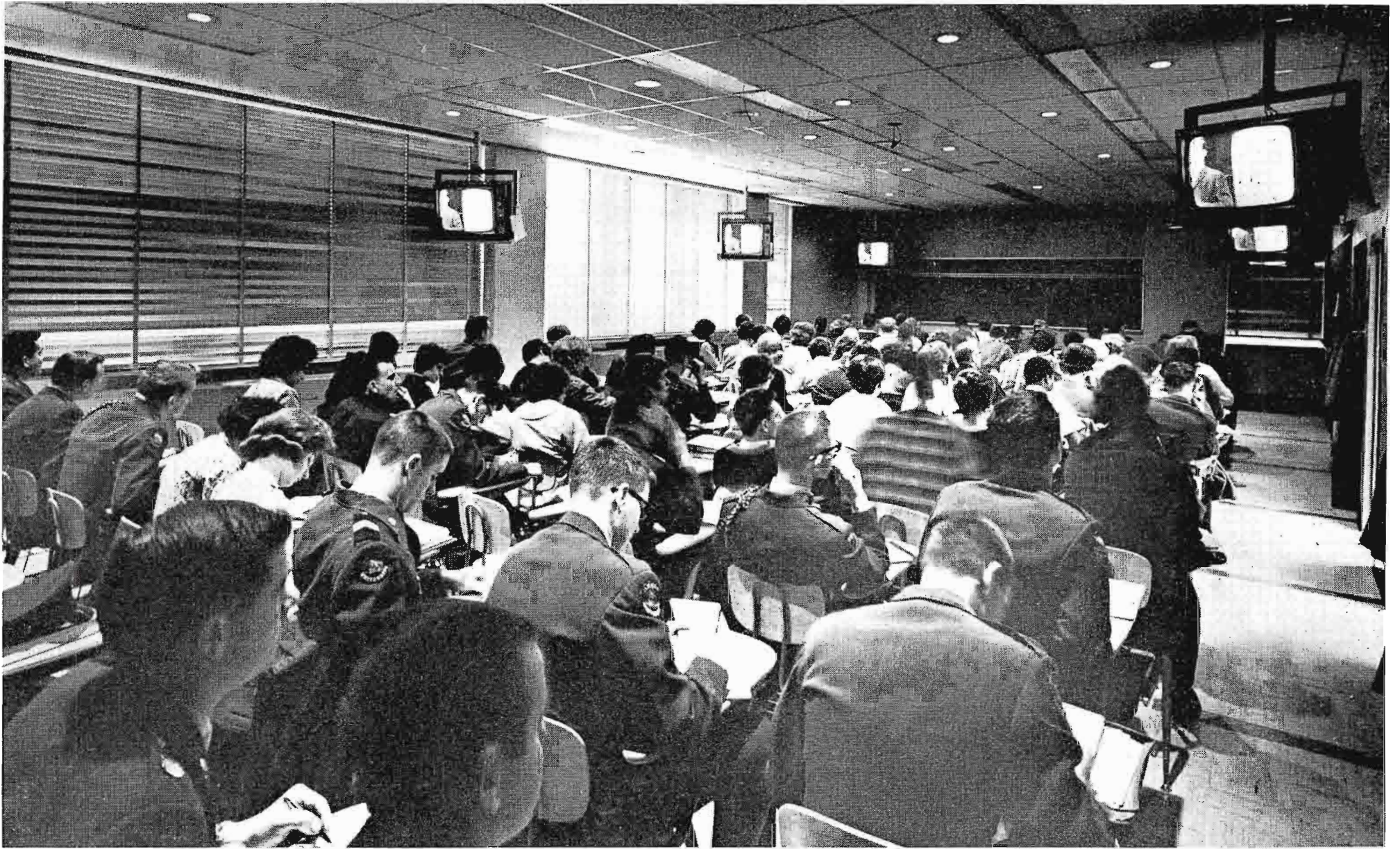

▲ FIG. 11. "Reasoning and Understanding in Science" Class. Special lighting provides adequate illumination for note-taking.

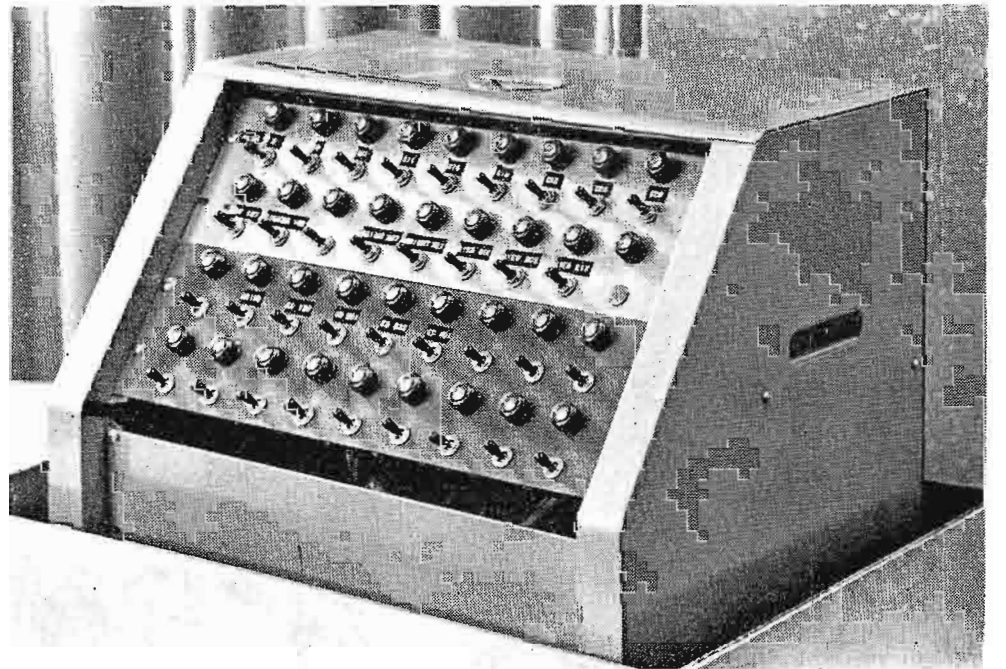

▲ FIG. 12. Instructor's studio talk-back console. With this instrument the TV instructor can enable any viewing student to be in direct communication with the TV center.

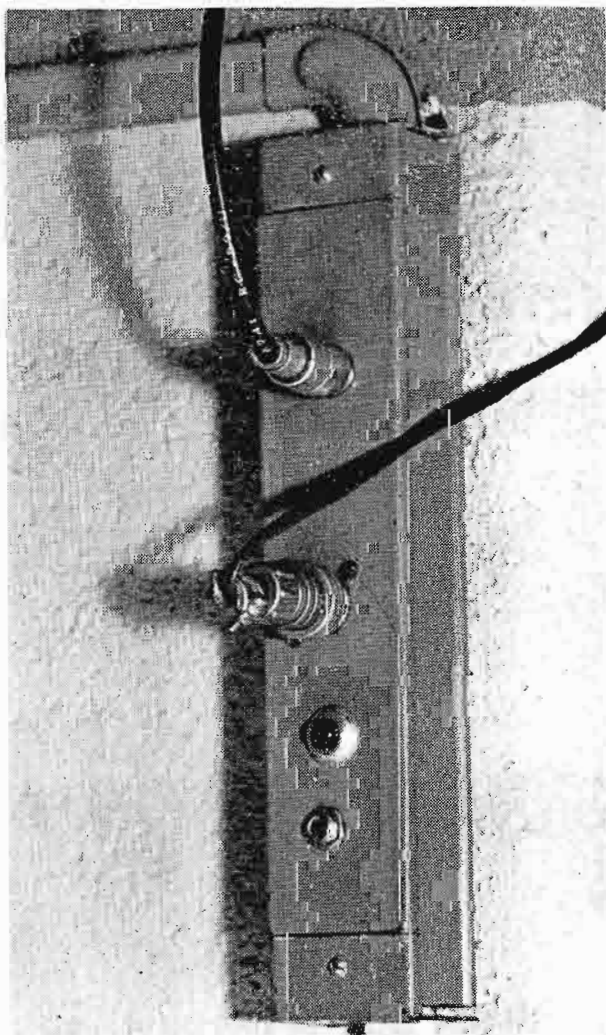
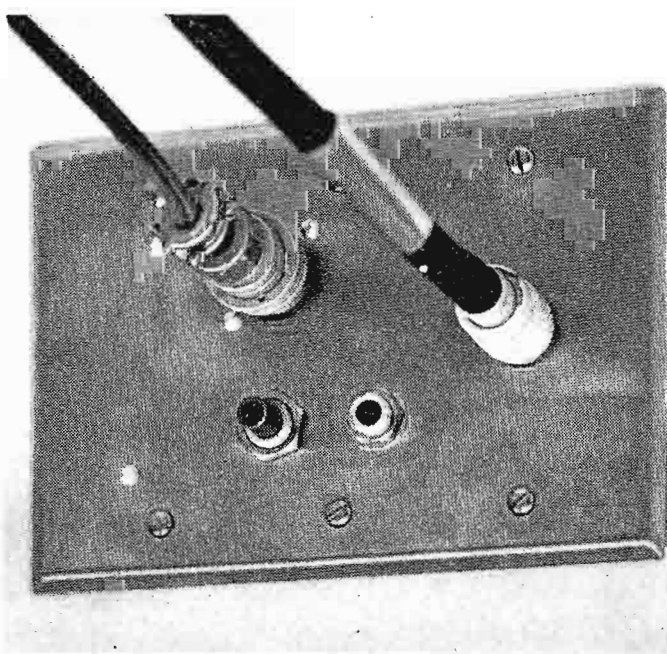

FIG. 13. Classroom TV control stations showing RF and receiver muting cables, talk-back push-buttons, and technician phone jacks. (Left) Surface mounted. (Below) Flush mounted.



third is in Kolbe Hall; each has its own audio line amplifier. Figure 14 shows the Education Building Talk-Back control rack.

The Education Building

In the Fall, 1962, a new Education Building was completed. Several special TV features were built into this new location, including complete wiring for TV reception and talk-back communication.

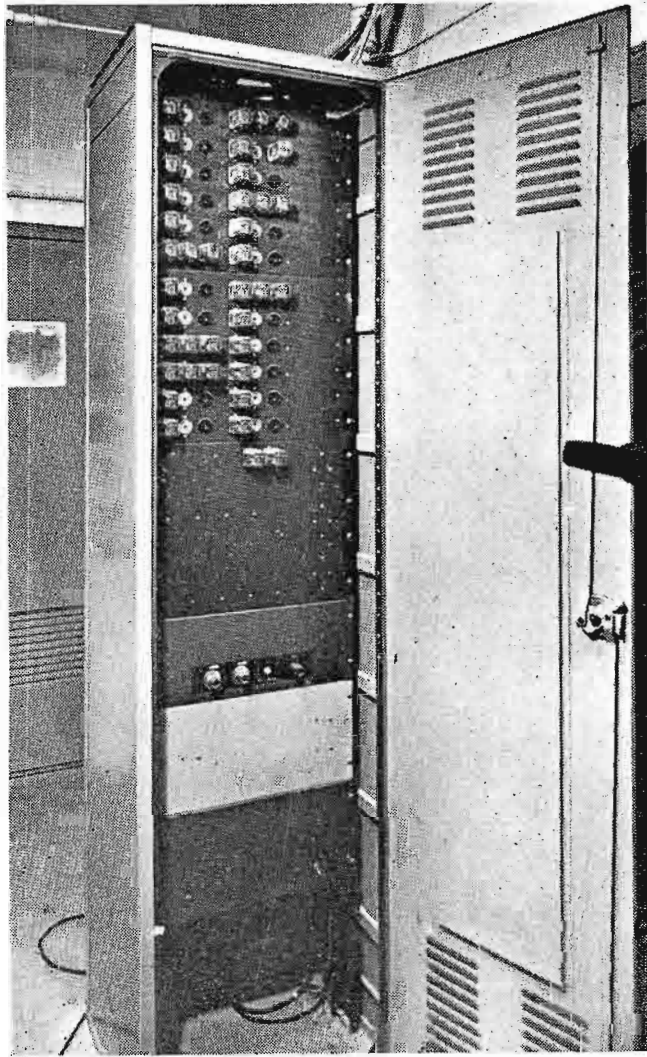

FIG. 14. College of Education talk-back control rack. Contains audio line amplifier, RF amplifier, relays and associated circuitry.

One room was designed to function as a second TV studio-classroom. Portholes were built into both front and back walls of the room so that actual classes might be televised without having cameras within the room. Figure 15 shows this area.

Special lighting, including power-groove fluorescent lamps, was provided above a plastic grid ceiling. For TV use the level of light in the room is 375 ft.-candles. A TK-15 camera is mounted at the front port for class observation, and a TK-21 camera is mounted on a remotely operated pan and tilt at the rear port for observation of the instructor and his activities.

A small control room is located adjacent to the special Studio-classroom. Camera controls, switching arrangements, and audio pick-up from all points is handled here. The video and audio signals can be sent either to the main TV Center in Kolbe Hall for distribution via the main rf cable to all receiving points on the campus or directly to the large lecture room.

Two other pick-up points are provided—one in a hall close to two small conference type rooms where a TK-15 camera can be located so that it can point into either of these rooms, and the second is in the large lecture-auditorium where the intent is to permit the use of a TK-21 camera for specific visual aids purposes such as magnification of small items, charts,

etc., for presentation, within this room, via TV, to large groups of students.

The lecture-auditorium seats approximately 260 persons and is equipped with eight 23-inch RCA table model sets, mounted on brackets suspended from the ceiling. These brackets were designed and built at the university. The receivers in this room were modified to receive either rf or video. A special distribution system was installed for this rf or video application. Figure 16 shows this multi-purpose lecture-hall.

All camera control and audio equipment in the Education Building was made portable so that these cameras, with their associated components, could be easily transported around the campus. Remote pick-ups from the University Computing Center in Buchtel Hall are being used in conjunction with several mathematics courses. Provision is made for televising computing equipment and processes for incorporation into lectures originating at the main TV Center or for direct origination of lectures from the Computing Center. A small remote talk-back console is also available so that questions can be asked of the Computing-Center instructor.

Multiple Response Indicator

One complaint from instructors using TV is that there is no immediate way of judging how well their lectures are being received by viewing students. The Head of the Electrical Engineering Department is designing and building a device which will permit an instructor to instantly determine how well the class is receiving material. All student chairs will be wired with five push-buttons in a manner which will prevent any student from seeing the responses made by any other student. The instructor will present a question having five possible answers. The student will react by pressing one button only. An indication of this choice will appear on one of five meters located on a console in the TV studio. The instructor, from a glance at the meter panel, will know whether he has developed his current concept as well as was intended. If so, he can proceed to the next step in his lecture with a reasonable amount of confidence about student readiness for new material.

The device can also be used for giving multiple-choice tests containing as many test items as desired. This system is being designed so that it can be connected into the Computing Center where a tabulation

FIG. 15. TV studio-classroom showing TK-15 Camera mounted in front port. Insert shows TK-21 Camera mounted in rear port. There is 375 ft.-candles of illumination in the room.

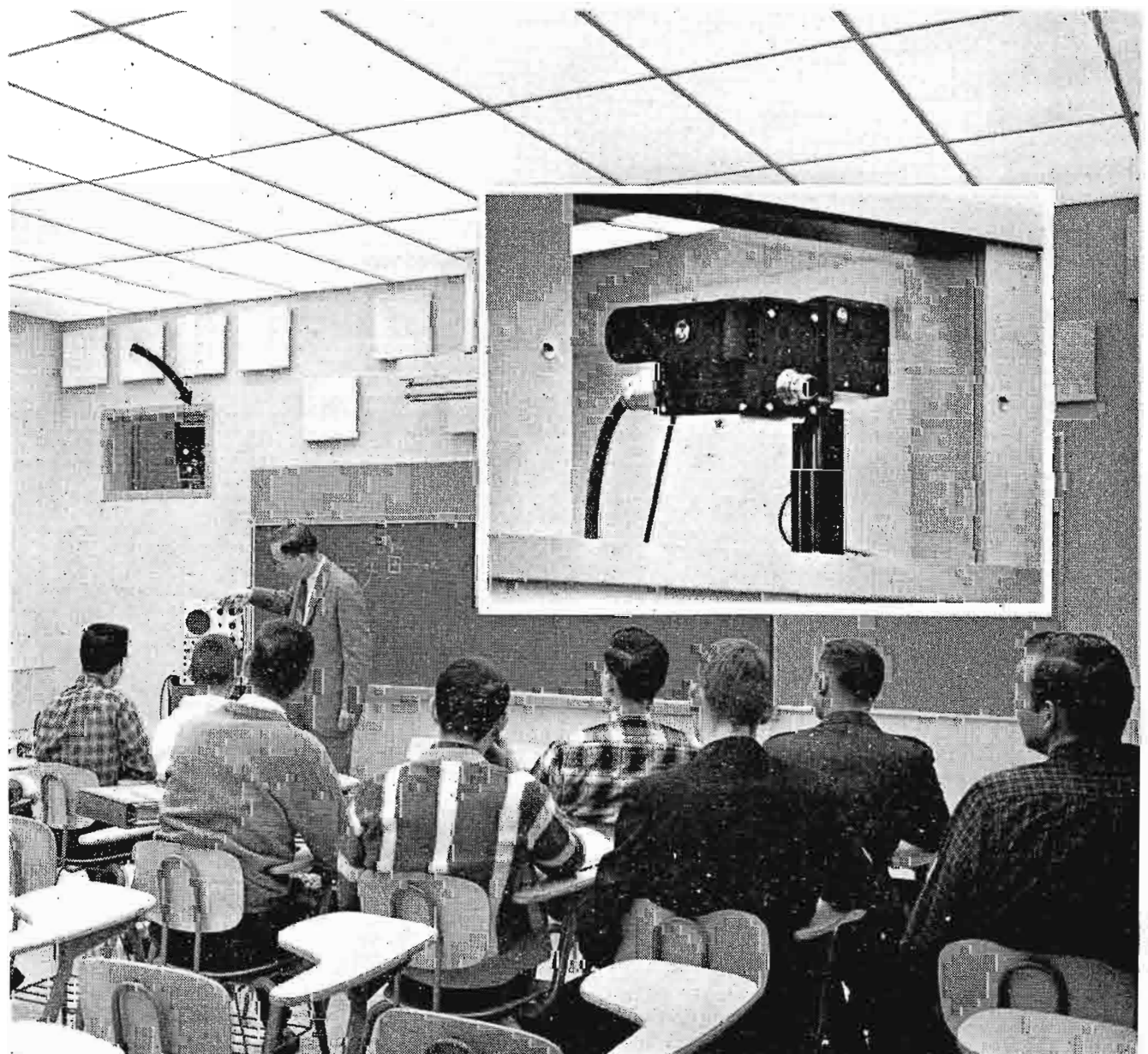

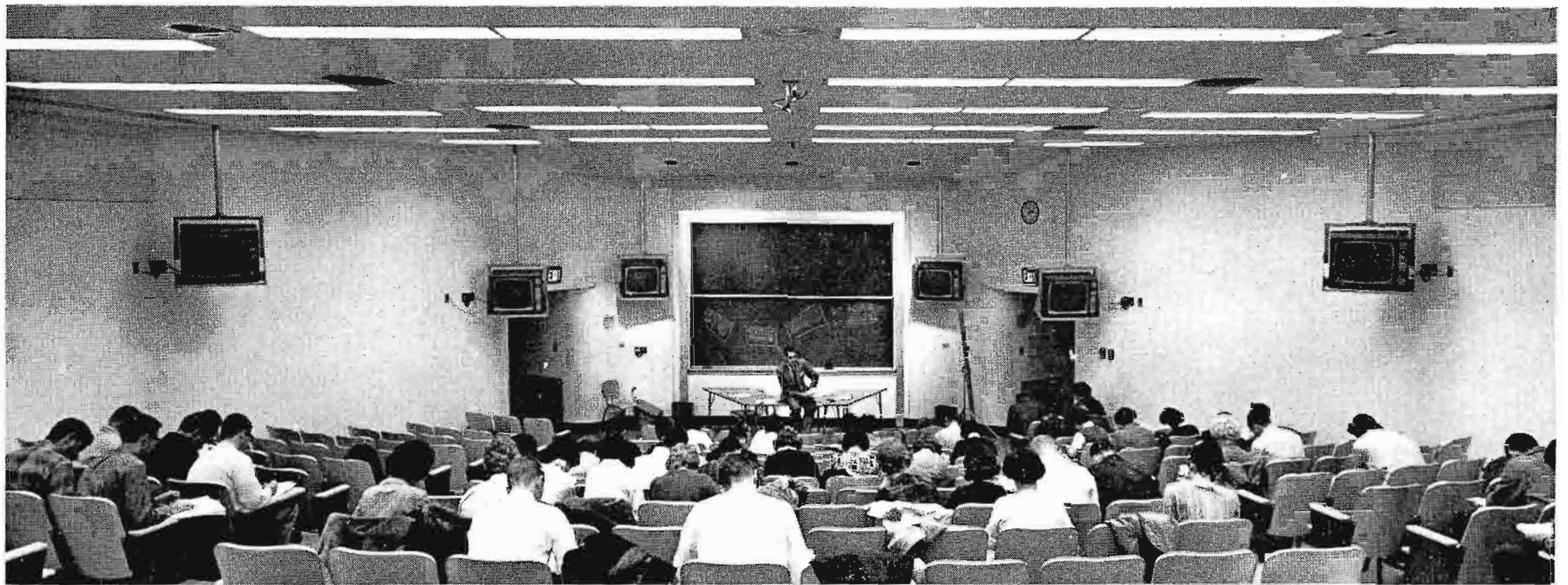

FIG. 16. Education Building Lecture-Auditorium. Here a group of students are discussing concepts which were presented moments earlier over TV by the Psychology Professor.

of all responses by each student, as well as his total grade, can be made available to both student and instructor within 20 minutes after completion of the test.

General Observations

Forty required courses (amounting to almost 1300 hrs. of TV presentations) have been taught in full, or in part, to almost 13,000 University of Akron class registrants since February, 1961—a period covering five semesters. This includes the Spring, 1963, semester. Reasoning and Understanding in Science, Education in American Society, General Psychology, Analytic-Geometry, Algebra-Trigonometry, Analytic Calculus, Military Science, General Inorganic Chemistry, Effective Speaking, and Institutions in the U.S.A. are some of the courses which have been, and are being, taught through television.

Other specialized TV applications have included the presentation of: Freshman Orientation programs; professional broadcast training; extra-curricular forensic union debates and discussions; and demonstrations for various educational and public associations.

What reaction has there been to this utilization of electronic aids in education on this campus? In January, 1963, Dr. D. J. Guzzetta, Vice President and Dean of Administration made the following observations among others:

"In the overall picture, all electronic devices enable us to do a better teaching job because we obtain better utilization of faculty time.

"Everybody has a front row seat with TV. Thus, the use of small visual-train-

ing aids is more effective because all students are able to see them well—a situation which is impossible in large lecture classes.

"According to instructors, students do at least as well—perhaps better—where TV is used to supplement a shortage of qualified teachers in crucial areas of instruction.

"We know that one good teacher in a TV classroom is worth more than several inexperienced or mediocre instructors in conventional lecture rooms.

"Another major advantage of TV is its capacity to relay uniform background material for observation by discussion-type classes (which are normally unsuited for TV lectures) . . . With TV, they can all observe the same situations—a real advantage for purposes of discussion and testing."

Dr. Thomas Sumner, Dean of the General College and Professor of Chemistry who has been teaching the required sophomore course, Reasoning and Understanding in Science, via TV, has commented:

"I think that TV is particularly applicable to large lecture-type classes. Formerly, not only was I unable to use visual materials effectively, but there were very few questions asked by students. Right or wrong, it's true that most students won't ask what may turn out to be a 'stupid question' while face-to-face with the instructor. They will, however . . . anonymously phrase a question (via talk-back) to an instructor who's halfway across the campus.

"We can do more for the good student with TV because he can see and hear better than in a conventional class.

"A big advantage for the instructor is that he needn't teach the same course two or three times the same day . . . As

there's no need to be monotonously redundant, the teacher is more stimulated right from the start.

"Of course, we must remember that TV is not 'all or nothing'—some courses feature one-out-of-three weekly classes on TV and the rest are discussion or question-and-answer sessions.

"And, for those who become agitated at the mention of 'visual aids', it is necessary only to remind them that TV is one in a long series of visual aids, of which the greatest is the book. Like the book, TV's effectiveness is dependent upon intelligent and judicious use. As with any aid to education TV simply helps people to help themselves."

This discussion has centered on Instructional Closed-Circuit Television. However, the University of Akron has also established an FM radio station, electronic language laboratory, and a computer center as integral parts of the educational complex within the past two years.

Planning is currently underway which could result in the on-campus production of televised courses that would be transmitted by closed-circuit to one of the major industrial corporations in the area. These courses would be taken for university credit by company employees at the industrial site.

As the educational demands continue to increase, educational leaders must continue to bring into existence the means by which these needs must be satisfied. Perhaps by the end of 1963 the University of Akron will witness greater advances toward Broadcast Educational Television. Television tape recording could make further changes in teaching-learning patterns. And the concepts underlying Programmed Learning certainly won't be overlooked by farsighted teachers.

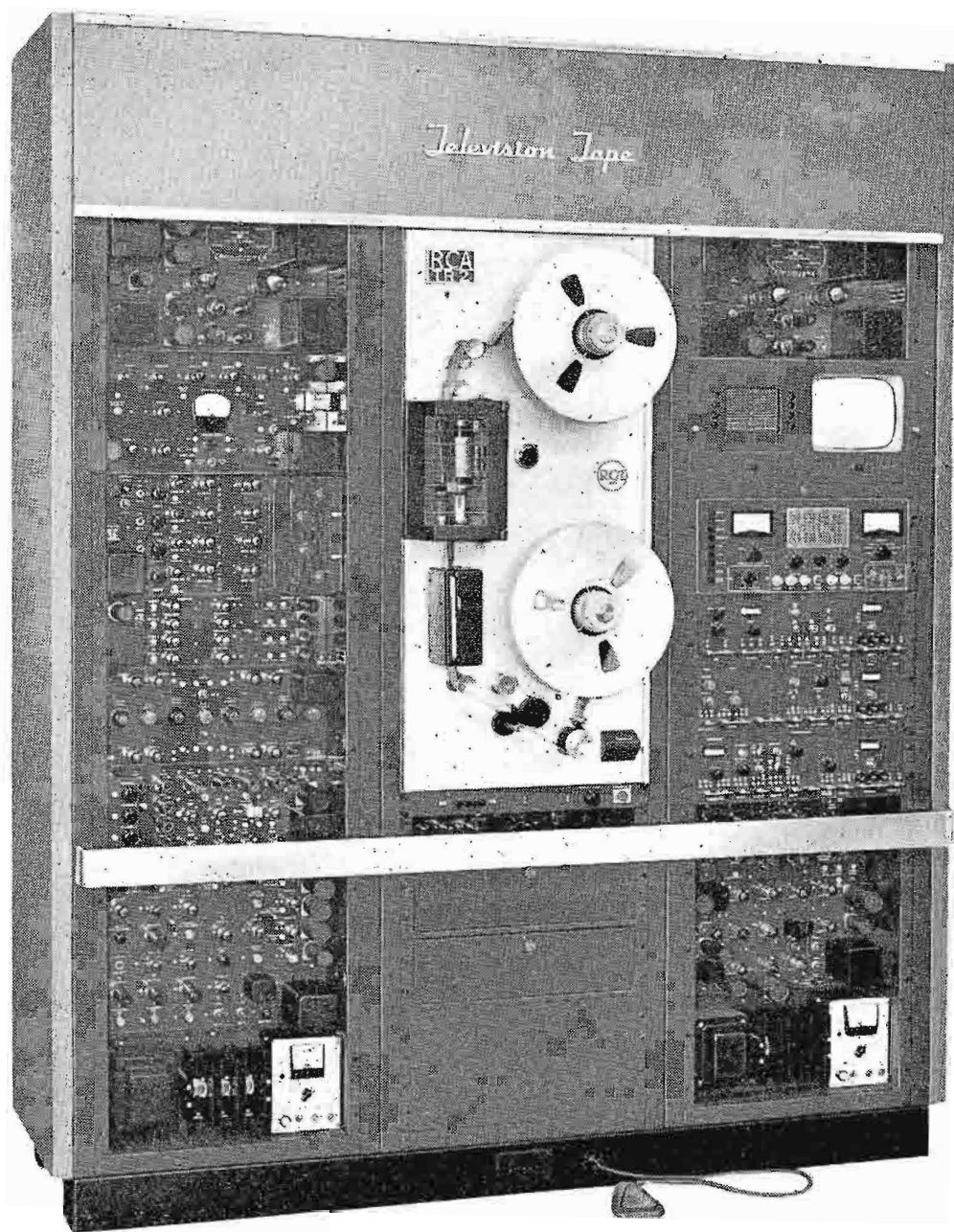

FIG. 1. The TR-2 TV Tape Recorder is a compact compatible quadruplex recording center for monochrome and color operation.

TV TAPE RECORDER TYPE TR-2

Basic Compact,
Adaptable to Color,
Accommodates
a Full Line of
Accessories

by H. H. KLERX
RCA TV Tape Merchandising

The RCA Type TR-2 basic quadruplex TV Tape Recorder has been developed to meet the increasing need within the TV Tape recording industry for a compact, lower-cost equipment which maintains high standards of performance, reliability, and interchangeability—and is suitable for color tv operation.

The TR-2 maintains all the excellent performance specifications characteristic of its famous predecessors, and at the same time offers new features not found in many recorders today.

Features include: Compact size (3 rack units), low cost, and choice of two models (the standard studio model and the short-rack model for mobile units). A complete line of accessories is available to enhance programming flexibility and operating convenience, and to make the TR-2 recorder an excellent choice for any TV Tape recording facility.

Full Line of Accessories

The TR-2 will accommodate a wide range of accessories. These are available for either the standard or mobile type recorders. Basic accessories include:

1. Air Bearing Headwheel
2. Pixlock
3. Two-speed Operation
4. Picture Monitor
5. Waveform Monitor
6. Audio Cue Channel
7. Automatic Timing Corrector
8. Color Playback Accessory

Compact, Partially-Transistorized Design

One of the basic objectives considered in the design of the TR-2 was to reduce the size, weight and power requirements, and at the same time to include the latest advances in the state of the art. The equipment utilizes proved designs and provides proved performance. In fact, the TR-2 is essentially an outgrowth of the well known TRT-1B and TR-11 Recorders.

Transistor circuitry has been included liberally in the design. The areas of transistorization have been carefully selected to materially improve performance and conserve space. As a result, the TR-2 is not only a compact recorder offering superior performance, but it also accepts a wide variety of accessories that can be integrated in the basic TR-2 cabinet.

The highlights of the new TR-2 design will be covered in detail, but are summarized as follows:

1. Simplified control panel
2. Precision transistor headwheel servo
3. Transistorized 4 by 2 switcher
4. Electronic quadrature alignment
5. Color adaptability
6. Studio and mobile models
7. Complete line of accessories

Simplified Control Panel

The control panel of the TR-2 is functionally laid out to provide all operating controls and adjustments at the operator's fingertips. Figure 2 shows the convenient grouping of these controls. At the left of the panel there is a series of nine push-button switches, pre-wired to key signal circuits within the recorder. These push-buttons permit a rapid check of the overall stability and performance of the system, and they are arranged to provide three signal feeds to the picture monitor and nine signal feeds to the waveform monitor. The operator may readily check these nine key signals to determine the "go" status of the recorder.

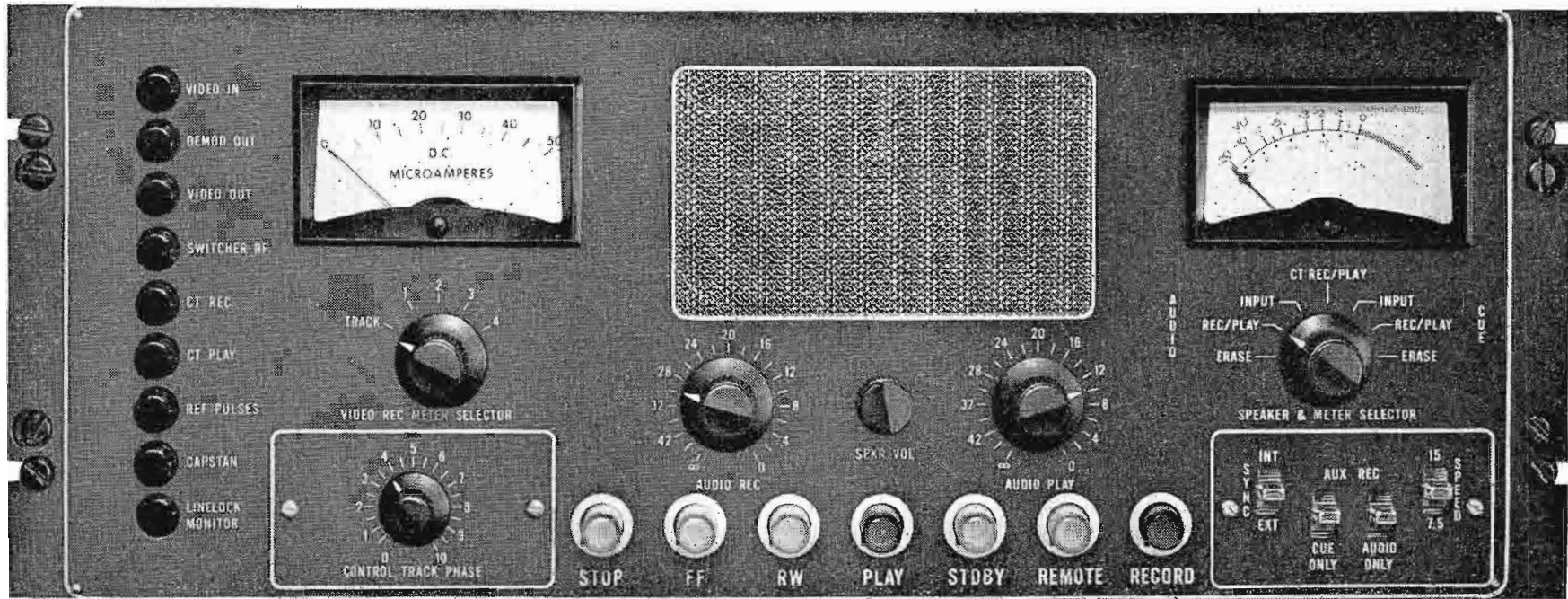

FIG. 2. The functional arrangement of this compact control panel expedites setup, check-out, and operation of the TR-2 Recorder.

The first position, *Video In*, provides both picture and waveform observation of the incoming signal to the recorder. The second position, *Demod Out*, provides picture and waveform observation of the demodulator output, thereby providing an immediate check of the FM system in the recorder. The third position, *Video Out*, provides both picture and waveform observation of the signals leaving the tape recorder. In this position, video, pedestal and sync levels can be determined; also a continuous check on the quality of the outgoing signal can be performed.

The remaining push-button positions switch signals to the waveform monitor only, while the picture monitor remains on the *Video Out* position.

Position four, *Switcher RF*, provides a waveform display of the 4 by 1 switcher output. In this position the four rf channels in the recorder can be monitored to determine proper head optimization levels and other important performance characteristics. Position five, *Control Track Record*, provides a waveform display of the control track signal being fed to the record head. The sixth position, *Control Track Play*, provides a waveform presentation of the control track signal during playback and, in addition, simultaneously monitors

playback of the control track signal while the recorder is in the record mode of operation.

The seventh position, *Reference Pulses*, provides a waveform display of the reference pulses, and, in addition, superimposes on the picture monitor reference pulses from the tonewheel—providing a quick check of the headwheel servo stability. The eighth position, *Capstan*, provides a waveform display of the capstan servo signal indicating overall stability of the capstan servo. The ninth position, *Linelock Monitor*, provides both picture and waveform display of the output signal. This position also switches the picture monitor to external sync so that critical observation of pixlock (optional accessory) can be observed. In addition this position also monitors the switchlock mode, which is a standard feature of the TR-2.

The horizontal row of buttons across the center lower portion of the control panel includes the *Stop*, *Fast Forward*, *Rewind*, *Play*, *Standby*, *Remote* and *Record* controls. The center of the control panel houses an 8-inch monitoring speaker driven by a transistorized audio amplifier. Audio record and playback level controls, as well as speaker volume control, are located directly below.

At the lower right of the control panel are located controls for selecting either internal or external reference signals during record or playback . . . also controls to permit recording of audio and cue signals only (if the cue accessory is installed). A two-speed control selector for 7½ or 15-inch tape speed is also provided on this control panel. This facilitates the installation of the two-speed conversion accessory and places this important control at the operator's fingertips.

A VU Meter is located to the right of the loudspeaker. This meter, with its associated selector switch, provides for monitoring of the erase, record/play and input audio signals, for both the program and optional cue channels. In addition, control track record and play signals may also be monitored by this meter.

To the left of the speaker is the video record current meter and selector switch. These permit checking the record heads of each of the four video channels. Another position on the switch permits a check of the tracking accuracy of the capstan servo. The control track phasing adjustment is located directly below these controls.

Precision Transistor Headwheel Servo

An all-transistor precision headwheel servo, see Fig. 3, is employed using modu-

FIG. 3. The completely transistorized headwheel servo features built-in switch lock operation. Pixlock operation is accommodated by adding a linelock module—fifth module from the left.

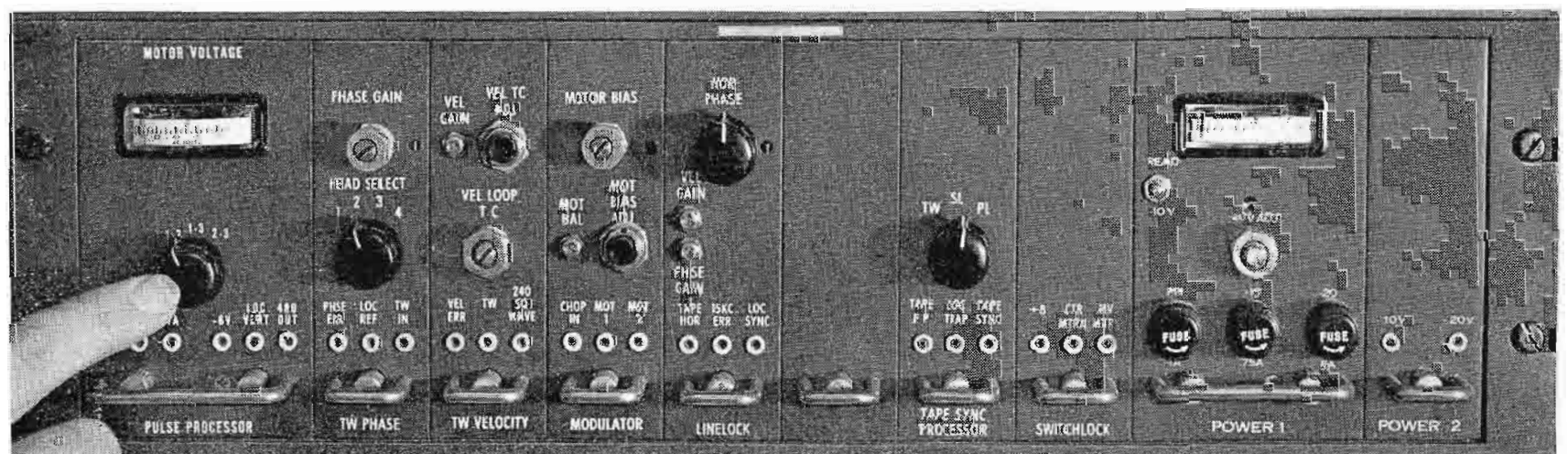

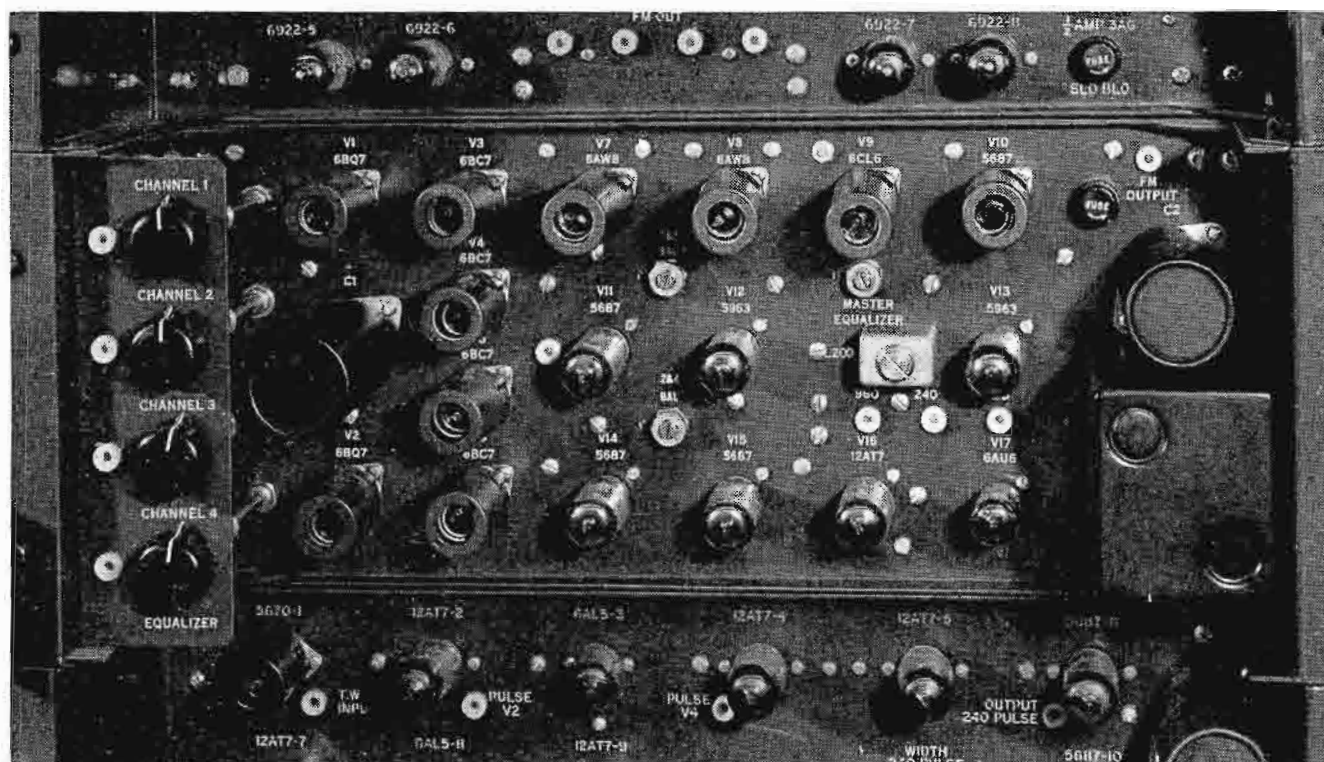

FIG. 4. All FM switching functions are included on a single chassis. A 4 by 2 rf switcher, fully transistorized, has been integrated at the rear of this 2 by 1 switching chassis. A 4-channel equalizer has also been incorporated into this basic unit.

of minutes. Independent delay lines are used in both record and playback, thereby permitting the operator to correct quadrature errors that may be present on tapes obtained from other sources. Four dual-concentric-shaft switch assemblies, with their respective delay lines, are mounted on a single electronic chassis. See Fig. 5. The record or playback delay lines are switched in and out of the circuitry depending upon the mode of operation. The inner knob controls precise quadrature when setting up the headwheel assembly in the record mode, while the outer knob sets precise quadrature when playing back tapes from the headwheel assembly.

Studio and Mobile Models

The studio-type TR-2 is available in a single unit (three racks) 69½ inches wide, 84 inches high, and 25 inches deep. For mobile applications, the TR-2 is housed in two separate units, each unit (two racks) measuring 66 inches high by 25 inches deep, by 47½ inches wide. The size and weight of this short-rack recorder makes it ideal for mobile applications as well as applications where portability or frequent change of location is desired.

Accessories

The block diagram, Fig. 6, shows where space has been provided in the studio model to accommodate accessories.

Air Bearing Headwheel

An air bearing conversion kit, including compressor and air filtering equipment, is optional equipment. When installed in the TR-2, this permits use of air-bearing as well as ball-bearing headwheels on an inter-

lar construction identical to the processing amplifier. (A module extender is provided with the recorder to facilitate all servicing of this type of equipment without removal from the recorder). The improved stability and simplified set-up adjustments of this new headwheel servo are important factors in obtaining consistent day-in, day-out peak performance. This servo system provides a choice of two modes of operation—normal tonewheel lock and switchlock. When in the switchlock mode of operation, it is possible to switch signals from this tape recorder along with any other studio signals and not experience the characteristic roll when the transfer of signals is being made.

A third mode of headwheel servo is available on an optional basis. Space is provided in the headwheel servo frame to accommodate a linelock module (fifth module from the left in Fig. 3) which then permits the recorder to be operated in a third mode known as Pixlock, which is described under *Accessories*.

Transistorized 4 by 2 Switcher

A single chassis incorporating all FM switching functions is used in the TR-2 recorder to accomplish head switching. See Fig. 4. This switcher provides a continuous FM output signal derived from the four record/playback heads located in the headwheel. A 4 by 2 rf switcher, fully transistorized, has been made an integral part of the 2 by 1 switcher, the output of which drives the demodulator. In addition, the 4-channel equalizer has also been incorporated into this basic unit, providing precise matching of response of the four magnetic heads during playback.

The sync separator, formerly a part of the 2 by 1 switcher, has been divorced from this unit and relocated in the main control panel. This function, too, has been fully transistorized.

The net effect of the changes made in the FM switching circuitry has been to reduce space and power consumption by a factor of almost 3 to 1, as well as localize controls—placing them within easy reach of the operator.

Electronic Quadrature Control

An improved form of delay line is being utilized in the TR-2 to provide precise steps of delay—enabling the operator to obtain accurate quadrature alignment, in a matter

FIG. 5. The electronic quadrature chassis incorporates improved delay lines and dual controls for both recording and playback.

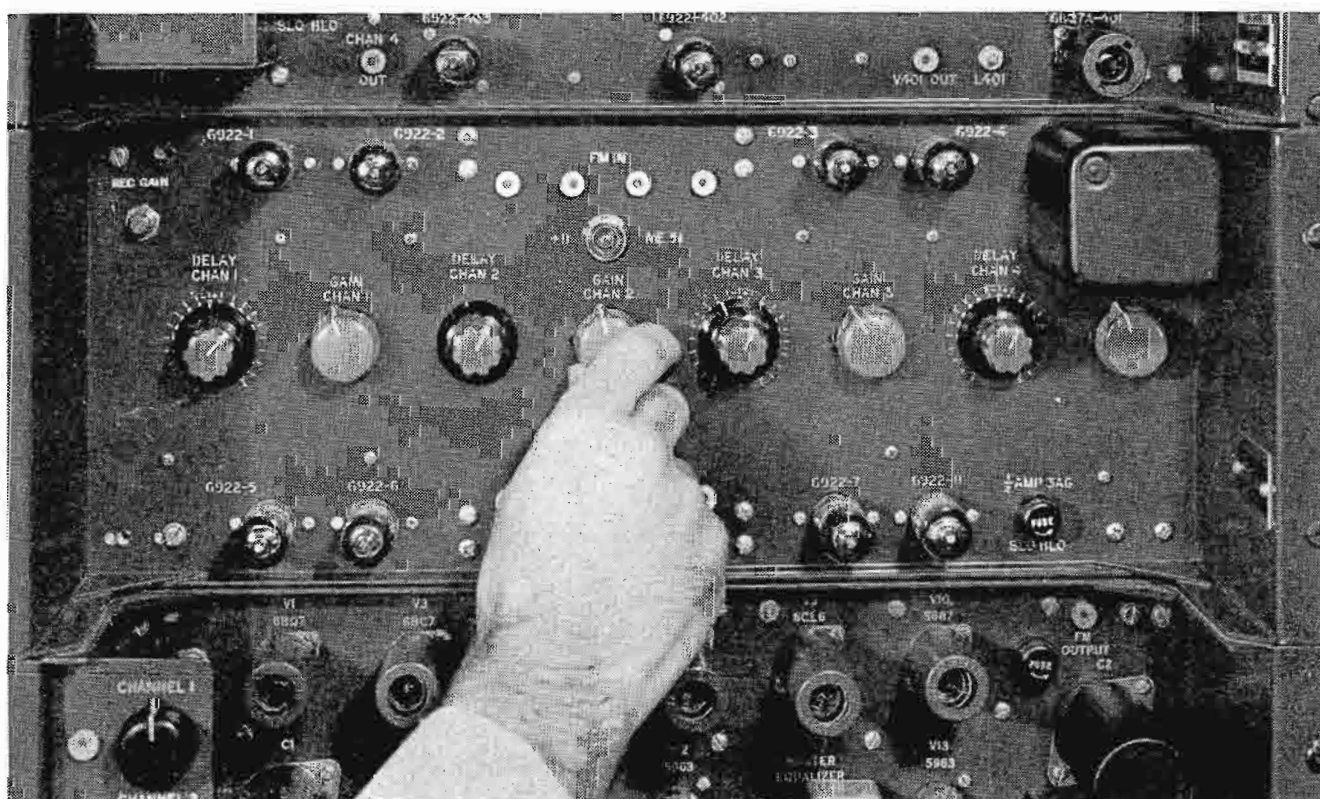

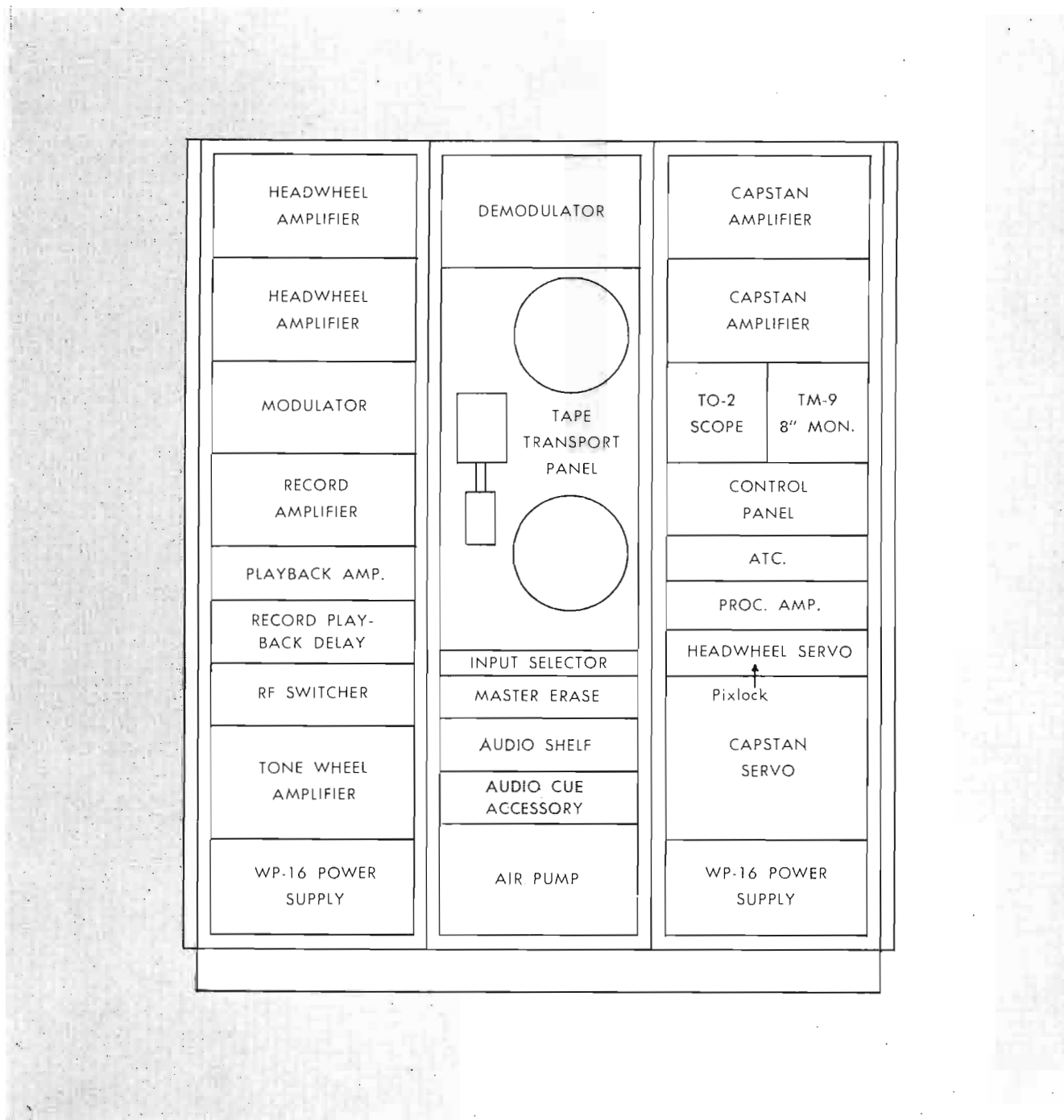

FIG. 6. Functional diagram of the studio model TR-2 Recorder. Mounting space which has been provided for optional accessories is indicated by the gray panels.

Two-Speed Operation

A two-speed conversion accessory is available for installation in the TR-2 recorder. Use of this accessory permits operation at either 7.5 inches-per-second or 15 inches-per-second tape speeds. Full compatibility and interchangeability is maintained at the 15 ips speed. At the 7.5 ips tape speed complete interchangeability is maintained with other RCA tape recorders equipped with this new accessory.

Significant advantages of two-speed operation are the increased recording time (up to 3 hours) and the significant reduction in tape cost.

The control circuitry required for this conversion is an integral part of the TR-2 recorder. A convertor panel (fully transistorized), a newly designed capstan motor, capacitor panel and pre-emphasis networks for the audio and cue channels are part of the conversion. These may be mounted on the rear of the recorder as shown in Fig. 7.

Operation of the TR-2 recorder with the two-speed conversion requires the use of a special narrow track headwheel assembly available in either ball or air bearing types. These headwheels will provide compatible recordings at either tape speed with imperceptible change in picture quality.

Picture Monitor

An 8-inch monitor for viewing the picture may be mounted in the TR-2 directly above the main control panel. The monitor operates on either internal or external sync, depending upon the position of the monitor selector switch.

Waveform Monitor

A 5-inch Type TO-2 Waveform Monitor may be mounted immediately above the main control panel, adjacent to the picture monitor. This waveform monitor has been specially designed for TV tape recording applications, with all frequently-used controls pushbutton-operated. Picture and waveform monitors are shown in Fig. 8.

Audio Cue Channel

Since the audio, cue, erase, record and playback heads are already a part of the

changeable basis. The chief advantages of the air bearing assembly are essentially jitter-free operation and longer life, resulting from the use of air-lubrication. Normally, the air bearing compressor and filtering equipment are mounted externally.

Pixlock

A pixlock servo accessory, fully transistorized and in modular form, may be plugged into the headwheel servo. A pre-

wired blank space is provided for the addition of this module. See Fig. 3. The addition of the pixlock accessory provides a third mode of servo operation—enabling the recorder to operate in complete synchronization with local studio signals. During playback, tape signals can be switched, faded, lap dissolved, super imposed or used in conjunction with electronically generated special effects.

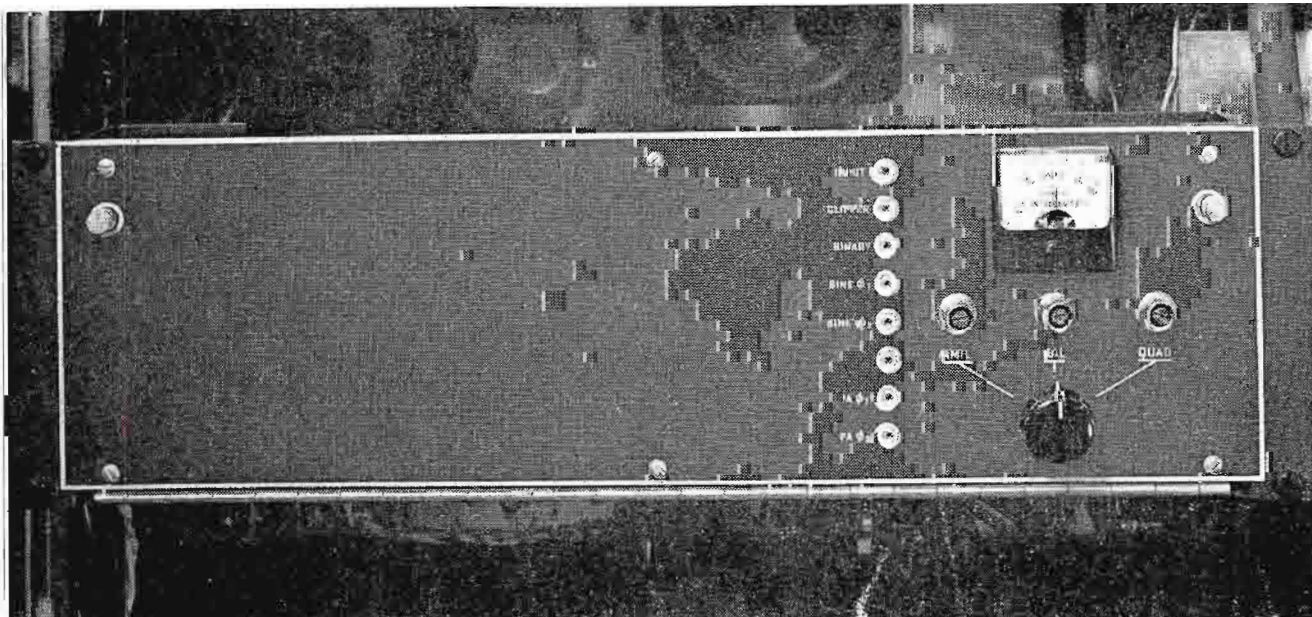

FIG. 7. The 2-speed convertor panel, fully transistorized, mounts at the rear of the tape deck. Control circuitry required for conversion to 2-speed operation is an integral part of the TR-2 Recorder.

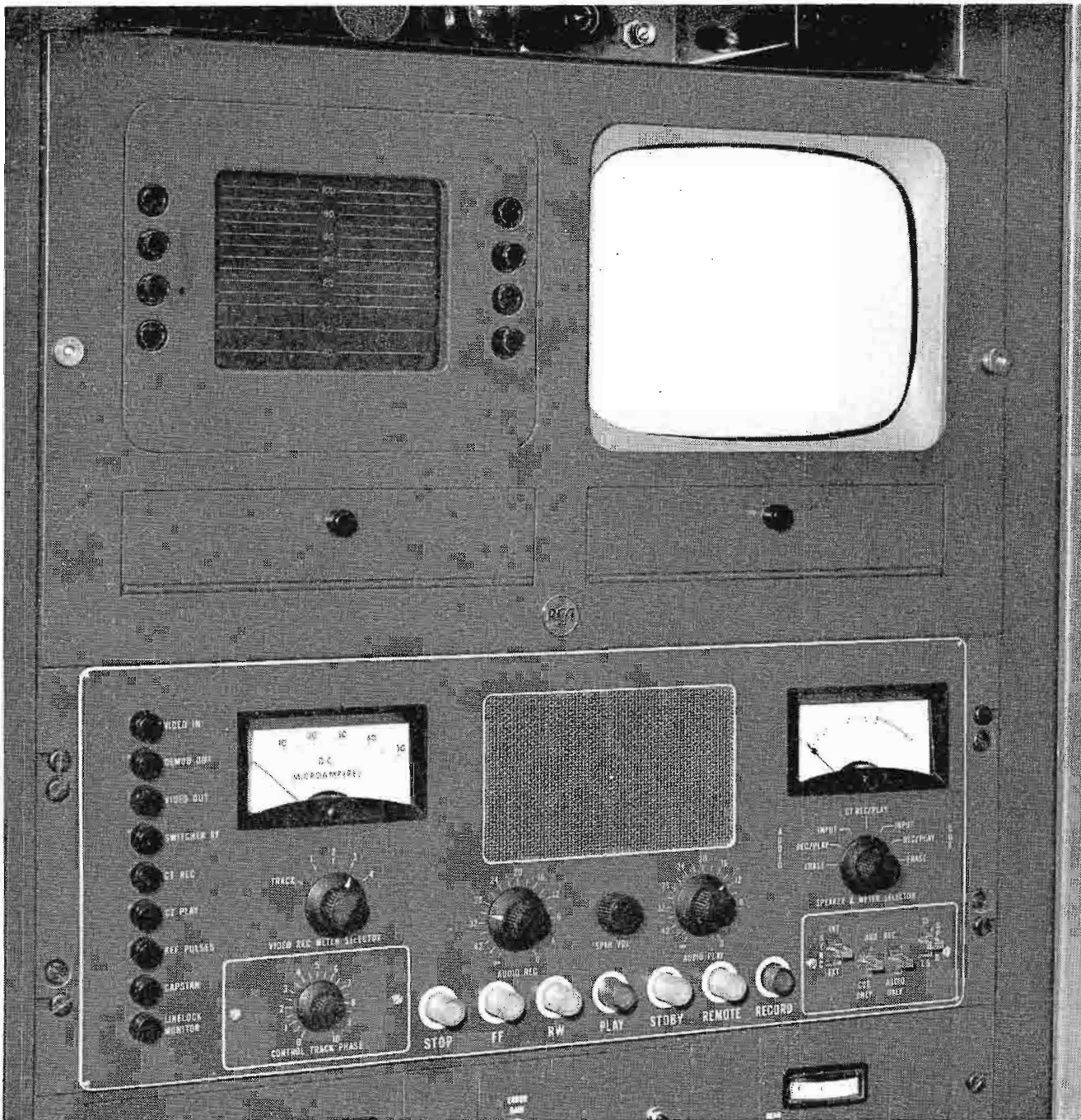

FIG. 8. An 8-inch picture monitor and 5-inch waveform monitor may be mounted immediately above the main control panel. These monitors are especially designed for tv tape recording applications—switching circuits for the monitors are built-in the basic recorder.

basic TR-2 Recorder, this accessory consists of the electronics required to complete the audio cue system in the TR-2. This accessory consists of a 5¼-inch shelf, containing the necessary amplifiers. It may be included in the TR-2 Recorder itself, since space has been provided.

Automatic Timing Corrector

The ATC accessory (see Fig. 9) is a fully transistorized unit, of modular construction, similar to the processing amplifier and headwheel servo. ATC is electrically connected between the demodulator output and input to the processing amplifier. Its primary purpose is to remove jogging or skewing and other geometric errors that can be introduced into the playback signal as a result of improper recording. In addition, it has the effect of improving the overall timing stability of the tape

FIG. 9. The automatic timing corrector (ATC) is a fully transistorized unit of modular construction, similar to the processing amplifier and headwheel servo. Its purpose is to remove skewing and other geometric errors in the playback signal.

recorder to a point where residual picture jitter is reduced to within 0.03 microseconds.

As mentioned previously, the electromechanical stability achieved by the pixlock servo (in the order of one-tenth

microsecond) is sufficient to achieve intermixing of tape and studio TV signals. The additional stability obtained with ATC (which further reduces this residual error electronically) provides almost perfect time relationship when intermixing tape and studio programs.

Color Accessory

Either the standard or mobile version of the TR-2 Recorder is capable of recording color signals. Playback of the signal will require the addition of the color playback accessory. For playback of color signals, this accessory is generally housed in a portion of a fourth rack.

To sum up, the use of these foregoing accessories makes it profitable to purchase the TR-2 as a basic unit with a view to adding accessories as the need develops. The accessories may be employed with either the studio or the mobile TR-2 Recorder. Many of the accessories can be installed in the TR-2 cabinet, while certain others are mounted in a separate rack. Use of the entire complement of accessory equipment requires only the use of a part of one additional rack.

Basic Recorder

The TR-2 is termed a basic recorder because emphasis was placed upon designing a quadruplex recorder capable of providing the user with a wide selection of accessories that can be added to suit individual requirements. As a result, the TR-2 meets high performance standards, at very low cost. Both the mobile and studio versions of the TR-2 Television Tape Recorder should find wide acceptance in an industry already familiar with the proven performance of other RCA Television Tape Recording equipments.



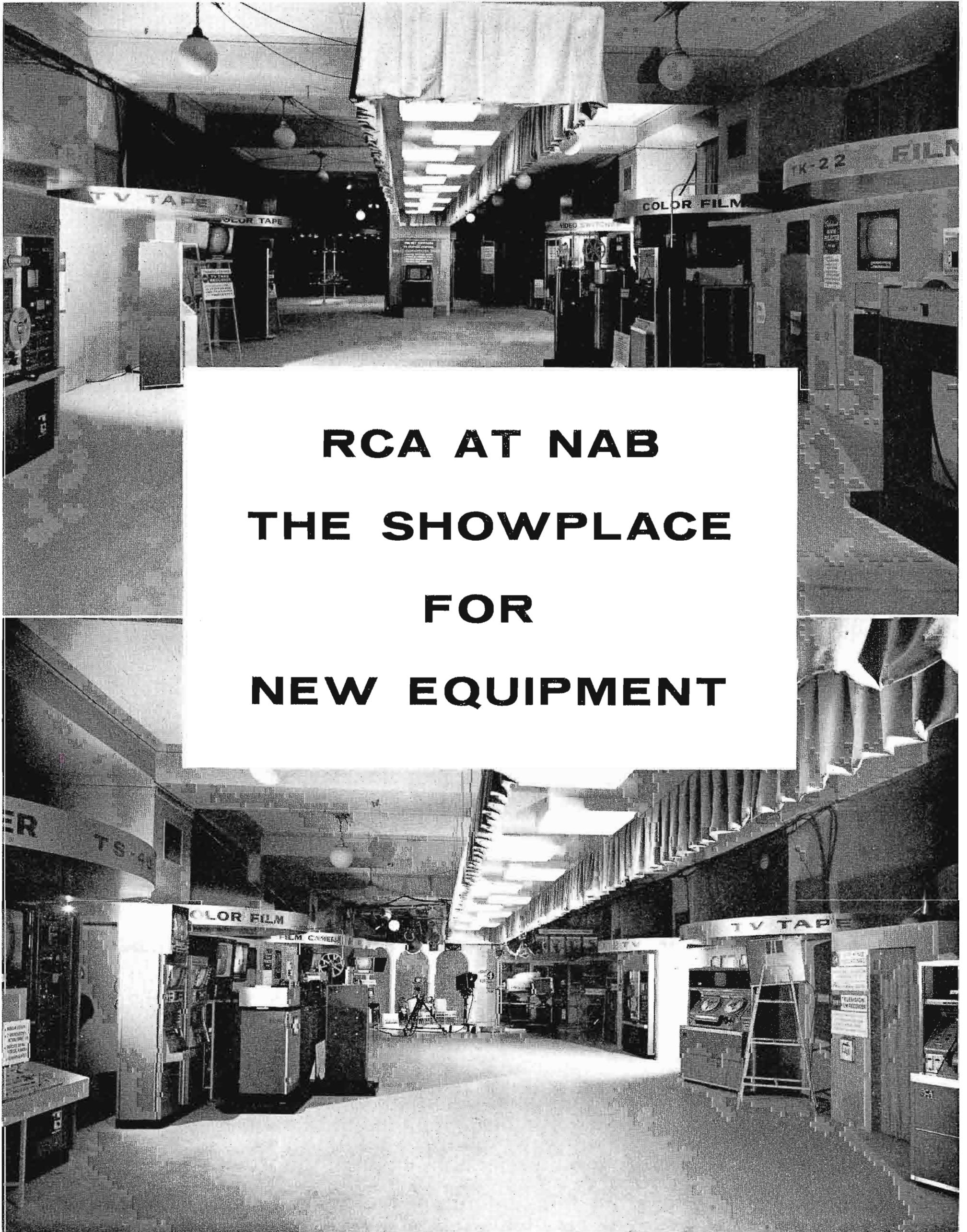

**RCA AT NAB
THE SHOWPLACE
FOR
NEW EQUIPMENT**



EVERYTHING FOR FM STEREO... AM AND TV AUDIO

Focal point of the RCA exhibit at the 1963 NAB Convention was the above spacious rotunda highlighting FM stereo operations and complete equipment for AM, FM and TV audio. From here, the visitors' attention was directed down a plushly carpeted center aisle around which was exhibited the industry's most complete and comprehensive line of radio and television broadcast equipment. The effect was much like that of a deluxe automobile showroom where latest model tv tape recorders, studio cameras, film cameras and projectors, switching and special effects equipment, audio amplifiers, audio consolettes, reel and cartridge tape recorders could be seen in operation. Also represented were TV transmitters, AM and FM transmitters, FM stereo monitoring and multiplexing equipment, antennas and transmission line, and automatic logging equipment.

Stereo Demonstration

Under the audio rotunda, operated a complete audio control center with special emphasis on stereo demonstration. Equipment in this area included the popular BC-7 dual-channel consolette, BCM-2 auxiliary mixer, a stereo-equipped RT-21 audio tape recorder, several cartridge tape units (including the new RT-37 stereo cartridge tape system) and a stereo transcription package (BQ-51 turntable, with BA-36 stereo preamp, 16-inch tone arm and universal cartridge).

New Stereo Cartridge Tape

On display for the first time, the stereo cartridge tape system is designed to the same high quality performance standards as its monophonic brother, the RT-7. Like the RT-7, it is fully transistorized.

The RT-37 system is particularly useful in producing local commercials with the

"presence" and added impact that stereo can bring to the sponsors message. Cartridges handle any type of programming from spots to a full 30 minute show.

The system consists of separate recording and playback units each $5\frac{1}{4}$ inches high and 19 inches wide for standard rack or console mounting. It features the use of three cue frequencies—a stop cue, an end of message cue and a trip cue (which may be placed anywhere on the tape to automatically trigger other studio equipment capable of being remotely started). Also featured are separate playback-record heads to permit simultaneous monitoring while program material is being recorded.

New Studio Consolette

Containing many of the operational features of the deluxe BC-7, a new studio consolette, the BC-8, provides dual channel operation with eight mixing positions. De-

signed for operating convenience and ease of servicing, the consolette offers two channel mixing and switching with monitoring facilities, plus dependable plug-in transistor amplifiers, low impedance mixing circuits, self-contained power supply and built-in cue/intercom amplifier.

Plug-in, unitized construction is the key to the flexibility of the BC-8A. The basic console consists of a wired housing including all operating controls, three dust-protected speaker muting relays, one VU meter, with provisions for adding an optional second VU meter, and the guide assemblies for accepting plug-in transistor modules. These comprise three preamplifiers, two program amplifiers, one cue/intercom amplifier, one monitor amplifier, one power supply, and two high-level isolation units. Plug-in units used are identical with those of the BC-7 Console and BCM-2A Auxiliary Mixer.



FIG. 1. Accent to the entrance of the RCA exhibit was this dramatic rotunda which served as an operating audio control center for AM, FM, and TV audio equipment.

FIG. 2. Deluxe BC-7 console featured stereo demonstration of reel and cartridge tape recorders and stereo transcription equipment.

FIG. 3. Highlighted amidst a complete line of audio equipment are a new BC-8 consolette, RT-7 cartridge tape system, and new RT-37 stereo cartridge tape equipment.



LATEST IN TV TAPE RECORDING EQUIPMENT

Three RCA tv tape recorders operated throughout exhibit hours to demonstrate the newest equipment available to improve tape operations. Two of the recorders were deluxe transistorized TR-22's — one of which was fully equipped for color, and the other monochrome. A third recorder, the TR-2, was completely fitted out with a line of block building accessories including Pix Lock, two-speed operation, picture and waveform monitors, audio cue channel and automatic timing corrector (ATC).

New Electronics for Color

Color demonstration of the TR-22 featured newly designed electronics called Color ATC (automatic timing corrector). The equipment used with the TR-22 com-

prises six modular units which are easily inserted in the video path to provide precise stabilization of color-signal reproduction. By measuring the residual "jitter" in a signal which has been pre-stabilized by Pix Lock and standard ATC, the Color ATC circuits electronically offer precise stabilization of such high accuracy that the color signal obtained is of high quality and requires no further processing.

The Color ATC has two modes of operation. In the first mode, the device is used to stabilize a normal color recording. In the second mode, the Color ATC is capable of stabilizing the chroma content of a second-generation color "dub" made by a demodulation/remodulation process. Further, the

Color ATC "senses" which of these two modes is required and automatically operates in that mode.

The Color ATC has no operating controls. It is placed in the circuit automatically by the selection of color-deviation FM standards, and its correcting action commences automatically when the pixlock servo achieves lock-up. The presence of burst on the reproduced signal automatically causes the insertion of regenerated burst at the output. Centering of the variable time-error correcting-element is also carried out automatically. There are only nine set-up controls associated with the Color ATC. These controls, once set, need no further attention for long periods.

FIG. 4. This deluxe transistorized TV tape recorder, TR-22, was completely outfitted for color taping. New color processing equipment is comprised of six transistorized plug-in modules accommodated in the module bank of the TR-22 recorder.

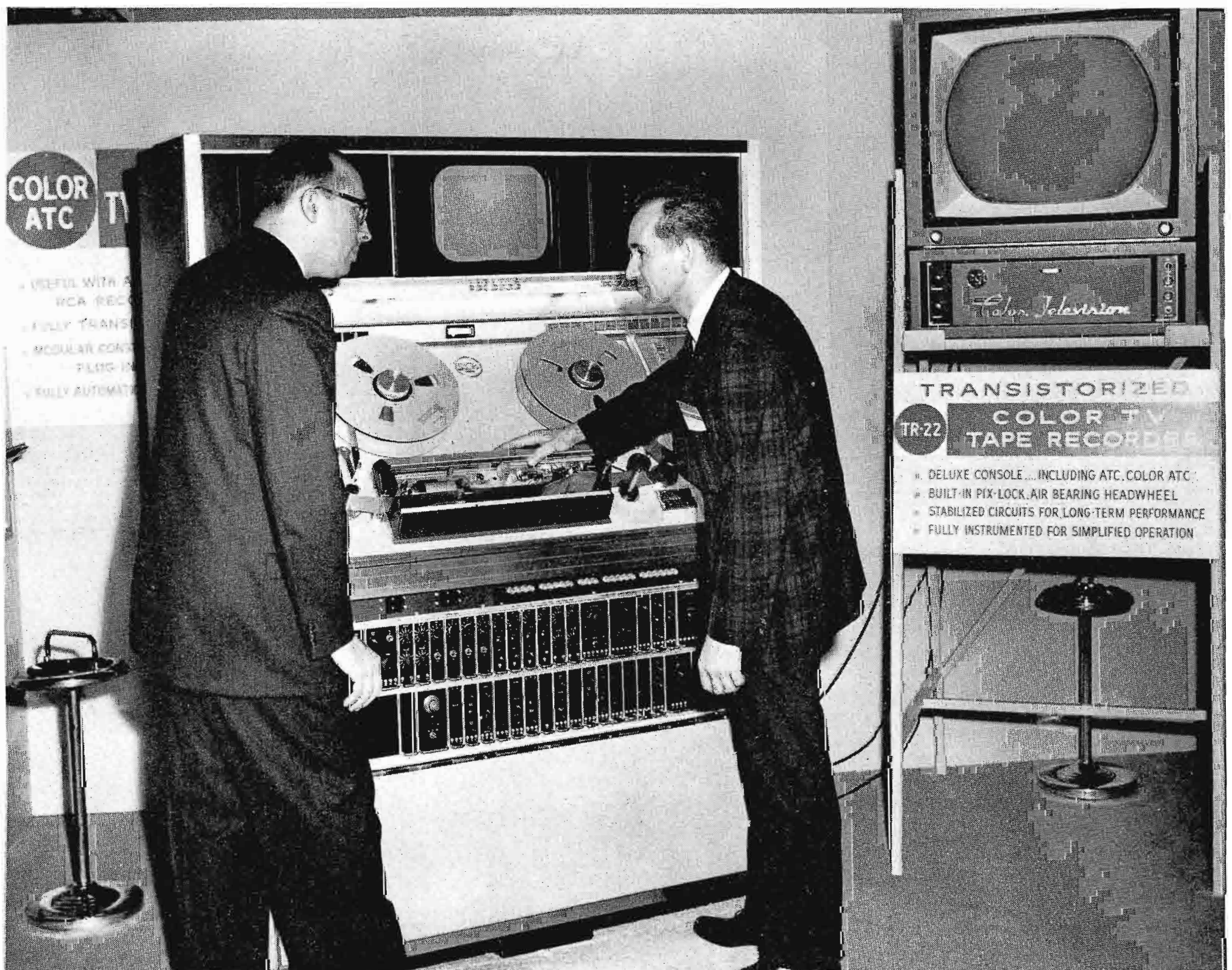

Basic TV Tape Recorder, TR-2

Also demonstrated was a basic quadruplex TV Tape Recorder, Type TR-2. It utilizes the same accepted design as the popular TRT series. The TR-2 embodies high standards of performance, reliability and interchangeability in a low-cost, compact unit.

Circuits of proved performance are utilized throughout. Also, transistors are employed wherever they do the most good in attaining materially improved results and significant savings in space.

A complete line of accessories are available individually, so they may be incorporated as desired into the basic equipment. These accessories include air-bearing headwheel, Pix Lock, two-speed operation, picture monitor, waveform monitor, audio cue channel, automatic timing corrector, and a color playback accessory. Space has been provided for housing most of these accessories in a standard three-rack unit.

As a result, the TR-2 allows the user to select a tape equipment to fit his immediate requirement, and at the same time, protect his future needs.



FIG. 5. A second TR-22 transistorized TV tape recorder was demonstrated in black-and-white operation at both half and full speed. Display at left provided pictorial comparisons of pixlock, automatic timing control and two-speed operation.

▲ FIG. 6. A basic quadruplex TV tape recorder filled out the tape equipment complement on display. The TR-2 shown here was fully equipped with Pixlock, two-speed operation, picture and waveform monitors, audio cue channel, and automatic timing corrector.





FIG. 7. Rack cabinet at left contains the BW-73A Multiplex Modulation Monitor; the TBM-3000 FM Frequency Monitor; the BTS-1A Stereo Subcarrier Generator and the BW-74 Modulation Monitor Stereo Adapter. The TT-25DH VHF Transmitter occupies center with the sections of the UHF TTU-12A/25B Transmitter at far right.

AM, FM AND TV TRANSMITTER EQUIPMENT

In the transmitter section of the RCA exhibit, there were two AM, one FM and two TV transmitters. Other displays presented automatic parameter-logging gear, modulation monitors (mono and stereo), subcarrier-generator equipment for FM stereo and transmission lines and antennas.

AM Transmitters

A 1-kilowatt, BTA-1R1, and a 5-kilowatt, BTA-5T, were displayed.

The BTA-1R1 is a self-contained, single-cabinet transmitter using only 5 tube types, an all-silicon-rectifier power supply and temperature-controlled crystals. The transmitter offers complete readiness for remote-control operation by including, as standard equipment, the control motor, relays and appropriate wiring.

The BTA-5T uses the recently-perfected high-efficiency Class "C" power-amplifier circuit configuration that increases PA efficiency 10 to 15 percent above that of a conventional Class "C" amplifier. Temperature-controlled crystals assure maximum frequency stability . . . summer or winter, even in unheated transmitter plants.

Automatic Parameter-Logging Equipment

Shown for the first time was a system proposed for strip-chart recording of as many as 22 operating parameters of AM, FM, or TV transmitters. The "heart" of the system is a synchronous "commutator" that switches the strip-chart recorder input to 22 (or fewer) transmitter test points once every 30 minutes. These test points can be power output, PA plate current, carrier-frequency monitor output, modulation monitor output, etc. The measurement is recorded on a moving strip chart in sequence. A feature of the system is an alarm which instantly indicates improper operation regardless of recording sequence.

FM Transmitter Display

Four pieces of station equipment were shown in the FM-transmitter display: a 5-kilowatt transmitter (BTF-5D); a multiplex-modulation monitor (BW-73A); a stereo adapter for the modulation monitor (BW-74) and a stereo subcarrier generator (BTS-1A).

The BTF-5D is a modern, efficient and highly reliable transmitter. Designed for

SCA and/or stereo programming, the exciter uses the RCA *direct-FM* (reactance) modulation technique. For simplicity, the system uses only two power stages (a 250-watt driver; 5-kw final) between the exciter output and antenna terminals.

The BW-73A Multiplex-Modulation Monitor is a self-contained device that is both a qualitative and quantitative facility for the various modulation levels in a multiplexed transmitter.

The BW-74 Stereo Adapter is the newest piece of equipment in this group. It extends the usefulness of the BW-73A by deriving *left-* and *right-*channel stereo programming for simultaneous monitoring in addition to accurately measuring the level of the pilot amplitude and the modulation level of each stereo channel. Audio outputs of 600 ohms are furnished for feeding suitable monitoring amplifiers.

The BTS-1A Stereo-Subcarrier Generator is designed for use with direct-FM transmitter exciters and is type-accepted for use with all RCA FM transmitters. Since its simplified circuitry is largely passive, only two tubes are used.

Television Transmitters

The "star" of the transmitter display was the TT-25DH VHF transmitter. This transmitter reduces the floor-space requirement to as much as 50 percent below the requirements of previous designs. Using a walk-in enclosure design, the TT-25DH eliminates the floor area dedicated to rear-access space without reducing accessibility.

A unique feature of the transmitter is the diplexed-amplifier configuration in the visual portion. Using Type 6166A ceramic tetrodes—each in an individual cavity—the transmitter combines the outputs of two 12.5-kw linear amplifiers to develop the 25-kilowatt (peak visual) power output. Diplexed amplifiers improve the picture quality of the air signal because the system reduces antenna reflections instead of retransmitting them.

A portion of RCA's 25-kilowatt UHF transmitter—the TTU-25B—was shown. The display consisted of the rectifier cabi-

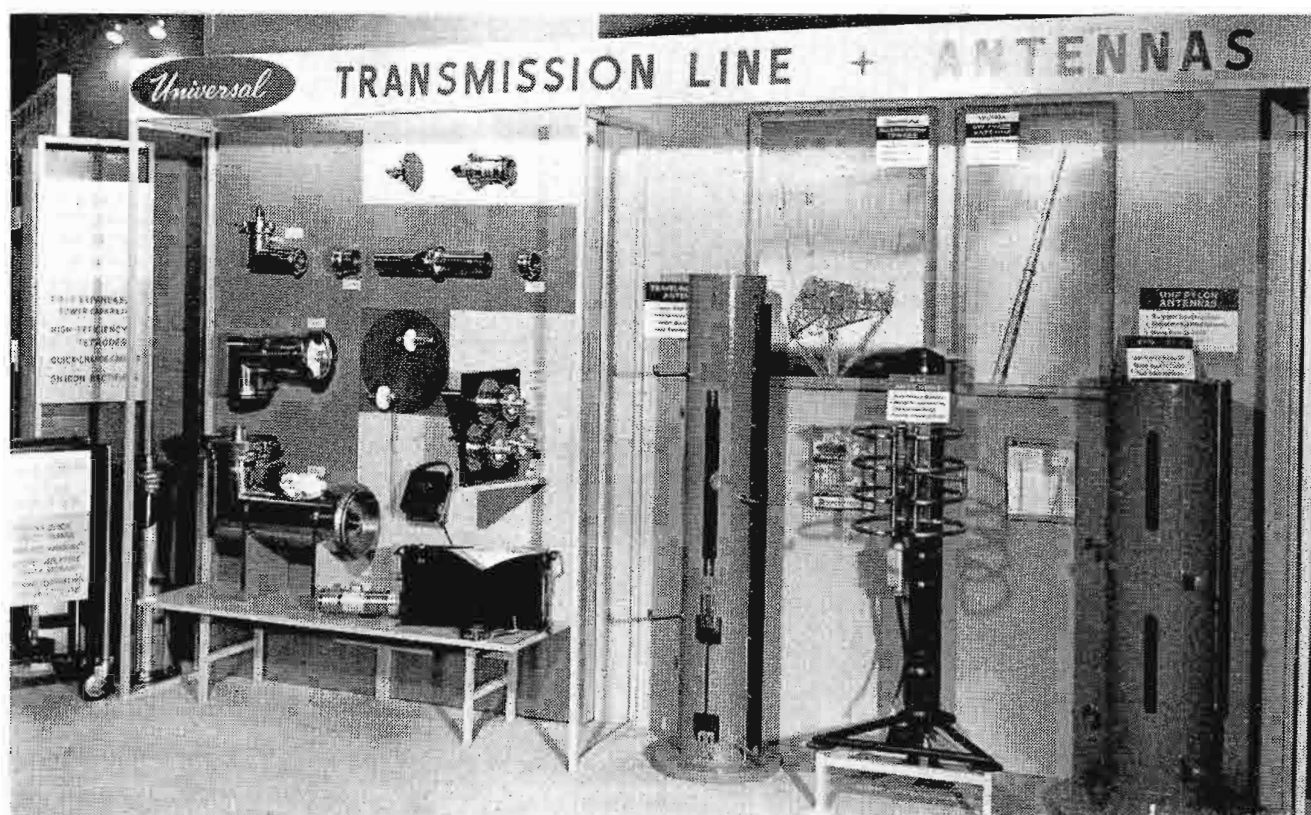

FIG. 9. Transmission line and antennas. The three elbows on the display panel (left) indicate the relative sizes of the 3-, 6-, and 9-inch Universal transmission line. The traveling wave-antenna section appears in the center of the picture with the BFA FM antenna section immediately to the right. A section of the UHF-Pylon antenna stands at the far right.

FIG. 8. Automatic parameter-logging equipment. Rack at left represents the studio portion of the system with the transmitter-located gear in the rack at right. The black box between the racks houses the demonstration controls for the automatic power-output control.



net and the cabinet containing the power-amplifier cavity. The quick-change-cavity design demonstrates the lightweight attributes of conventional-tube-amplifier design.

Universal Transmission Line

A specially-built panel supported samples of the 3-, 6- and 9-inch *Universal* transmission line for FM and TV use. Cutaway models displayed the "wrist-band" bullet design. This wrist-band bullet confines any copper shavings within the inner conductor, thereby eliminating insulator breakdown caused by accumulations of shavings on the dielectric material.

FM and TV Antennas

The antenna display consisted of three actual sections of transmitting antennas: two TV and one FM.

The FM antenna was a single section of the BFA series. These antennas use stainless steel radiating elements to prevent performance-degrading corrosion.

The TV-antenna sections, one VHF and one UHF, were cut-away to reveal the rugged internal construction. The VHF antenna . . . a "traveling-wave" . . . is available for high-band use in four power gains: 9x, 12x, 15x, and 18x. The higher-gain versions permit maximum power with a 25 kw transmitter.

UHF-pylon antennas, similar in appearance to the traveling-wave system, use a different operational principle, owing to the physics of the UHF spectrum. Available in power gains up to 52, the UHF pylon antenna is a rugged, long-life device.

NEW TRANSISTORIZED EQUIPMENT FOR THE TV FILM ROOM

A new monochrome film camera chain, TK-22, a new professional tv film projector, TP-66, and a look at the technological improvements that lie ahead for color film were featured in operating demonstrations.

4-V Color Film Camera

A developmental 4-vidicon color film camera demonstrated a number of advanced concepts, to be used in forthcoming equipment designs.

The equipment is completely transistorized and employs a 1½-inch vidicon for its monochrome or "luminance" channel which is entirely separate from the "chrominance" or color signal delivered by the red, green and blue one-inch vidicon tubes.

The four-tube principle has been com-

pared with four-color printing in which the imposition of black on the three primary colors enriches the hues and provides sharper definition in the finished picture. Picture quality is further enhanced by using the 50 per cent larger vidicon for the monochrome channel.

In producing the compatible color signal for broadcast, the three primary color signals are combined in a colorplexer and, after modulation, the luminance signal from the separate monochrome channel is added.

New 16mm TV Film Projector

Center of much interest and activity was the new TP-66 Film Projector. Its many advanced features include provision for automatic change of both projection and sound system lamps, virtually instantane-

ous start (three-tenths of a second), automatic cueing, reverse operation and automatic restoration of film loops.

Many of the normal manual-control operations, susceptible to human error, have been automated. Others are simplified to provide a projector designed specifically for the precise timing and reliability demanded by television.

Transistorized Vidicon Film Camera

Perhaps the most significant step in the transistorization of film equipment, was represented by the demonstration of a new monochrome vidicon film camera chain, TK-22. The new film chain uses a larger (1½-inch) vidicon pickup tube which boosts picture resolution to a new level of quality. To stabilize performance at this

FIG. 10. A look at the improvements that lie ahead for color TV film, was provided by this demonstration of a 4-vidicon, transistorized color TV film system.





FIG. 11. This display demonstrated transistorized equipment for the modern TV film room. Included were a new vidicon film camera chain, TK-22 (right), and a new 16-mm TV projector, TP-66 (left and inset photo).

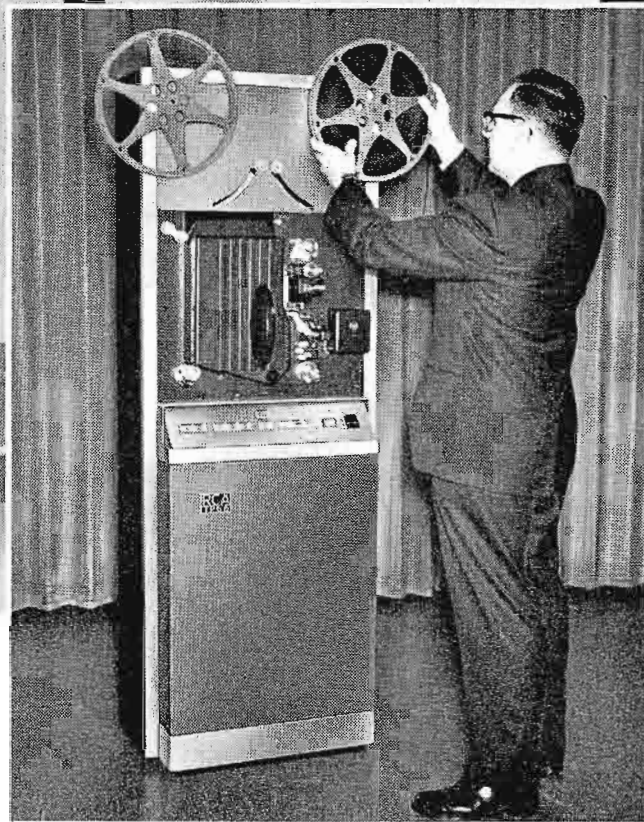

FIG. 12. Close-up of the TK-22 transistORIZED film camera and associated control and processing equipment. Control and processing units for two complete camera chains are mounted in the 5¼-inch rack frame shown.

high level, the new camera is equipped with automatic sensitivity control to assure consistent quality in TV picture output in spite of variations in film density.

The new camera's pickup tube is 50 per cent larger than the 1-inch vidicon used in current TV film cameras. Its introduction by RCA parallels the larger-tube trend in "live" TV cameras where 4½-inch image orthicons are replacing the 3-inch size for many applications. The increased tube size gives the electron beam a larger target to scan which, in turn, assures a sharper television picture, with greater detail.

With maximum transistorization in the TK-22 camera, substantial reduction in space required for the camera control unit is achieved. It takes up only one-eighteenth of the rack space required for earlier control equipment. The transistorized design also improves camera reliability and stability, reducing maintenance and lowering the heat level at which the TK-22 operates. Another benefit is in power consumption, which has been lowered to one-fifth the needs of current model cameras.



SWITCHING, EFFECTS, AND PRESET CONTROL SYSTEMS

Switching equipment on display included a TS-40 transistorized system, complete with special effects, and a new preset switching system, TSA-3, designed to reduce the number of technical operations required for tv station control.

Preset Switcher, TSA-3

Combining audio-video switching and machine start-and-stop in one unit, this new equipment allows a tv studio engineer to "punch up" as many as ten events in advance and to put them "on-the-air" by means of a single switching bar.

The equipment uses interlocked push-button switches to "memorize" a sequence of program segments and to control the tv projectors, TV tape recorders and other programming sources needed to put them on the air. As many as 15 video sources, with accompanying audio, may be connected to and controlled by the new system. In addition, six "audio-only" sources are available for use where sound other than that normally associated with the video source is desired.

The control panel employs backlighted pushbuttons—low brilliance for the preset condition and full brilliance for "on the air"—to give operator an instant read-out of current and upcoming program events.

Transistorized Switcher, TS-40

The TS-40 system on display is one of five standard systems available from RCA. These have been designed to meet a broad range of television switching requirements. The standard systems have been supplied for a large number of actual installations and are based on the needs of the majority of television studio operations.

Direct switching as well as a choice of picture transitions, including lap dissolves, fades and superimpositions, are accommodated. When used with RCA special effects system, TS-40 offers a brilliant variety of "electronic editing" techniques such as: split screen effects, wipes, picture inserts and traveling matte effects.

In addition, the switcher is available on a custom assembled basis to meet the exact requirements of almost any installation. Systems engineering assistance is available to aid in planning such custom systems.

FIG. 14. Close-up of TSA-3 preset switcher. Included at the control position are the preset buttons, power switch, remote delegate switches, input designations, and "Next/Event" switches. Relays and stepper switches for operating external devices (audio and video switchers, tape recorders, film and slide projectors and remote readout and control panels) are located on a chassis at the rear of the panel.



FIG. 13. Both color and monochrome performance of a typical TS-40 transistorized switching system with special effects was demonstrated in this display. A new line of transistorized Video Amplifiers (left) was shown for the first time.

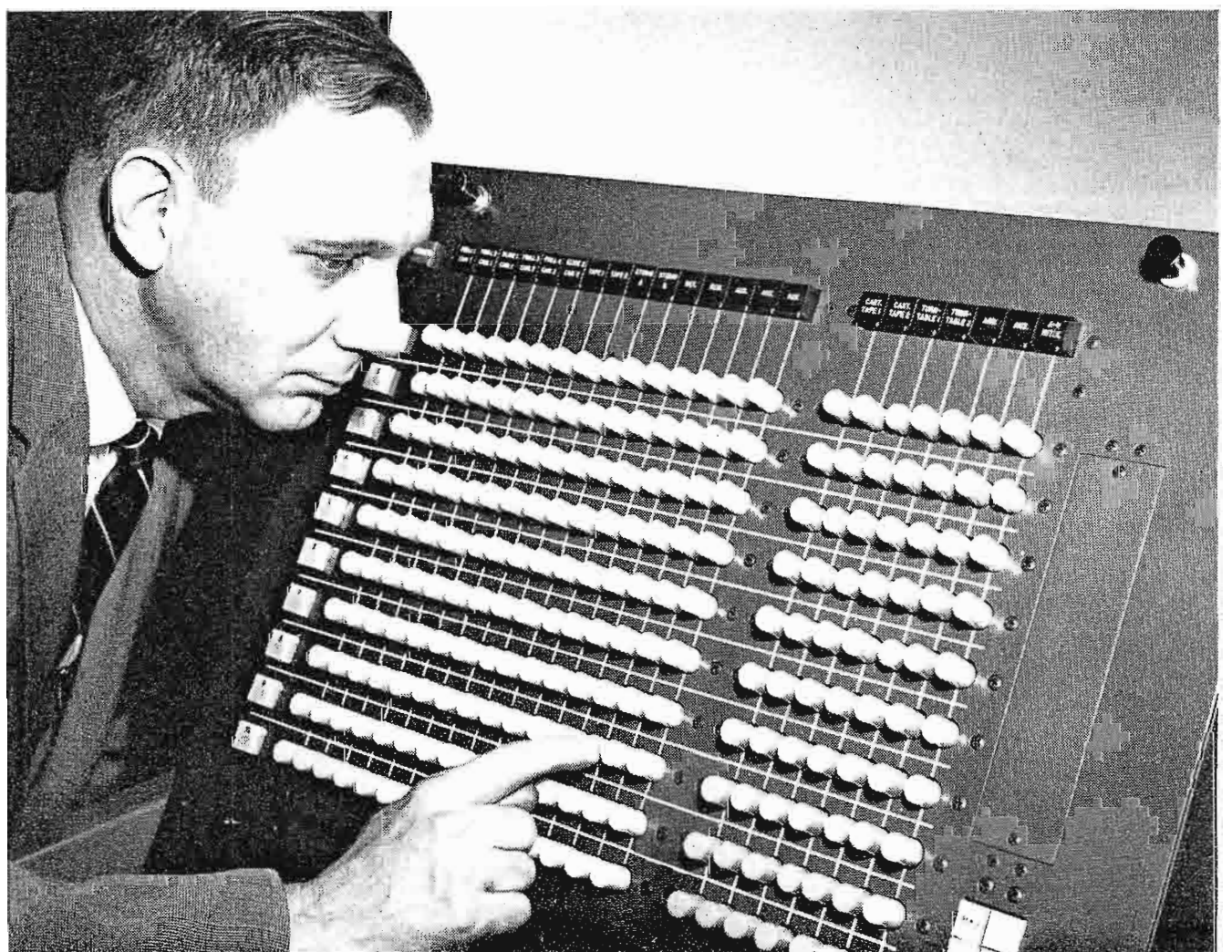

LIVE STUDIO FEATURES TK-60 AND TK-41 CAMERAS



FIG. 15. Live studio features a complete line of cameras. Monochrome and color pictures originated here. Studio lighting was by Kliegl and the studio floor was covered in "Montina Corlon" supplied by the Armstrong Cork Company.*

In the live studio, four television cameras were displayed in action. These included the TK-60 4½-inch Image Orthicon Camera, the new TK-14 3-inch Image Orthicon Camera, the TK-15 Professional Vidicon Camera and the TK-41 Color Camera. Each is designed to fulfill specific program requirements, thereby giving the broadcaster a wide selection of camera equipment to exactly fit his needs.

The TK-60 camera is designed specifically for use with the 4½-inch image orthicon to produce the ultimate in fine pictures. In addition, super-stabilized circuits assure simplified control and unvarying picture quality. Its striking appearance and built-in production features make it the deluxe monochrome camera of the RCA line.

Newly improved to get the highest picture quality from a 3-inch image orthicon, the TK-14 camera incorporates new advances in stabilized circuits and image orthicon shielding techniques. The shielding techniques eliminate cross-talk from

the deflection coils into the image section of the tube, and improve video response by a factor of two to one. New circuits also afford more precise focus current regulation and stabilization of the image orthicon control voltages. The result is finer picture quality and greater reliability from a 3-inch image orthicon camera.

The TK-15 is a professional-type vidicon camera, excellent for many studio situations and for closed-circuit use. It features simplified, low cost operation and maintenance. Equipped with Automatic Picture Control, the TK-15 adjusts itself for lighting variations to assure the best in vidicon pictures.

The TK-41 color camera needs no introduction—it has become the standard of the world. Recent improvements include precision yokes for accurate image registration, new prism optics which eliminate spurious reflections in the received picture, and stabilization of amplifier and image orthicon control circuits to simplify operations.



FIG. 16. New 4½-inch image orthicon camera, TK-60. The deluxe camera of the RCA line, the TK-60 produces the ultimate in fine TV pictures.

* Montina Vinyl Corlon is composed of vinyl chips of various sizes which capture the colorful veining of natural stone fragments. They are laid in a bed of translucent vinyl which gives a third dimensional effect to the flooring. Montina Corlon is recommended for installation above, on, or below grade. Its exceptional durability makes it ideal for heavy traffic areas.



WAVE-TV BRINGS LIVE COLOR TO LOUISVILLE

Equipped with Live, Film and Tv Tape Facilities,
17 Local Programs are Colorcast Weekly

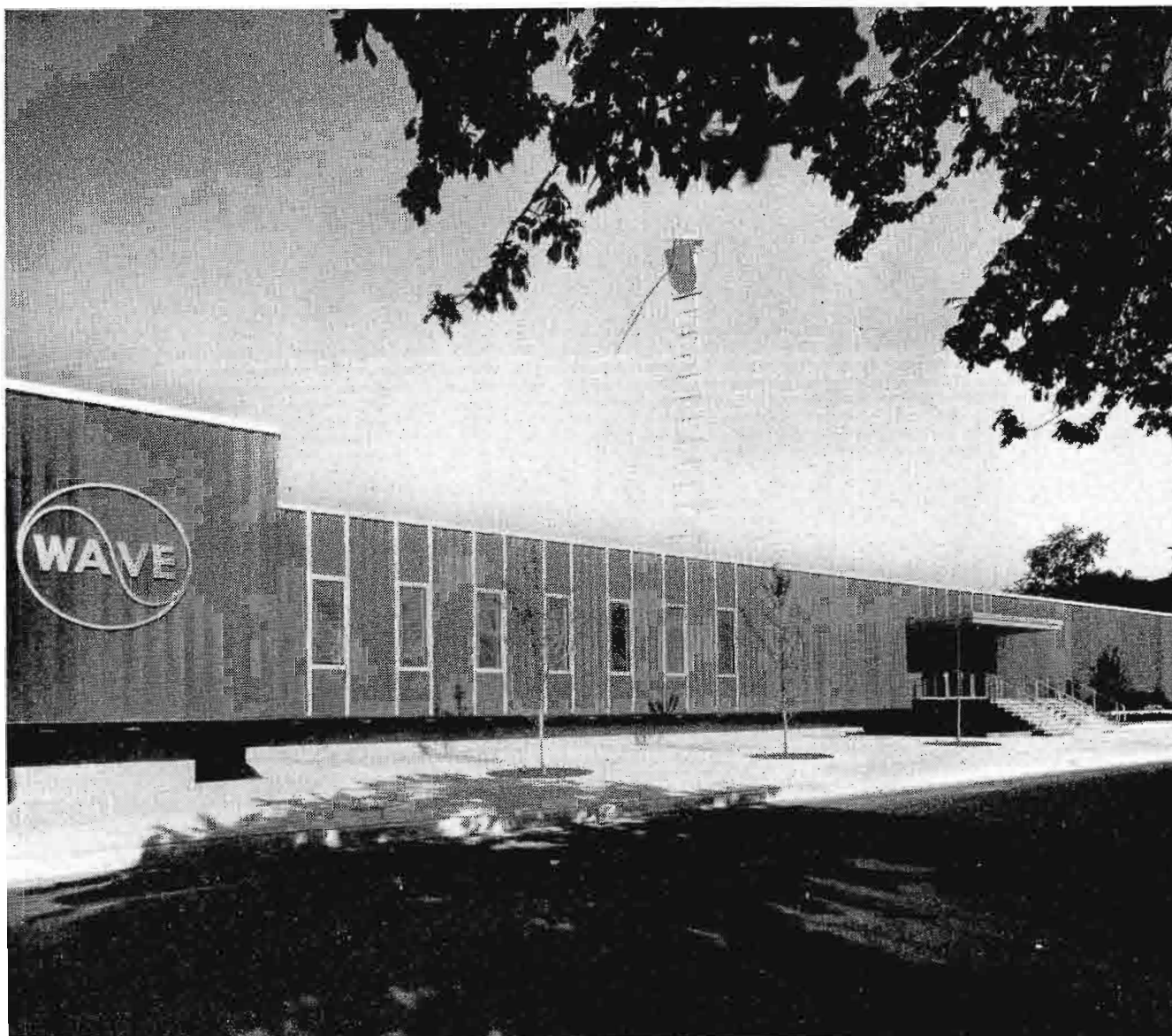

FIG. 1. New WAVE Radio and Television Center in downtown Louisville.

Television was brought to Kentucky for the first time in 1948 when WAVE-TV went on the air. Telecasting on Channel 5, at 24,000 watts, the station from the first was a basic NBC-TV affiliate. Progress was made in 1953 when WAVE-TV switched to Channel 3, with ERP of 100,000 watts, operating from a new 600-foot tower and transmitter at Bald Knob, Indiana. This increased the height above average terrain from 528 to 914 feet. However, the most important development occurred in 1962, when the station brought live color television to Louisville.

1962 Brings Color TV

Having transmitted network color since 1954, WAVE-TV became the first station in Kentucky to transmit live color on August 15, 1962. A gradual development thereafter was made in color transmission, so that by the end of the year, four programs were being telecast regularly in color, either live or on tape. In addition, three weekly half-hour film programs were being shown in color.

New Building Dedicated

WAVE, AM-TV, moved into its new Radio and Television Center, in downtown



FIG. 2. Weekly live color program "Kentucky Afield" combines studio demonstrations with film shot on location.

FIG. 3. Inner courtyard of new building, showing parking area in rear.



Louisville, July 1959. The new building makes a marked contribution to the rebuilding of the area, having won several awards for design and landscaping.

WAVE Inc. increased its holding in 1961 by purchasing WFRV-TV, Green Bay, Wisconsin, a 100,000-watt NBC affiliate, on Channel 5. This brought the total number of stations owned and operated to four: WAVE AM-TV; WFIE-TV, Evansville, Indiana; and WFRV-TV.

Radio Station WAVE went on the air in 1933 with a power of 1000 watts on 940 kc. Five of the original staff are still with the station: George W. Norton, Jr., President; Nathan Lord, Manager; Clifford Shaw, Music Clearance Director; Burt Blackwell, Chief Television Director; and Wilbur Hudson, Chief Engineer. A summary of the aims of WAVE is highlighted in these words from the station's opening statement: . . . "dedicating itself to the betterment and enjoyment of the people it serves, presenting programs of national importance, of local interest, music, sports . . ."



FIG. 4. Full-length opera "Beatrice" was commissioned, produced, and broadcast by WAVE to dedicate new building.



FIG. 5. TV tape color program "Excursion" is a series dealing with the arts.

Color Leadership in Louisville

by GEORGE W. NORTON, JR., *President, WAVE Inc.*

Today WAVE-TV has all the color facilities it is possible for a station to provide—live cameras, videotape, film, slide, and network color. We have expanded our color schedule as fast as possible, to the point where we are now doing 17 local color programs a week, including 11 live shows,

3 videotape programs, and 3 film programs. This constitutes more than half of our local originations.

There is no doubt that color is the TV service of the future, but to a large extent it is here now. More and more color sets are being made and sold every year. Al-

most all the major set manufacturers are selling color sets, offering a wide variety of makes to choose from. As it pioneered television in Kentucky in 1948, and first brought network color to Kentucky in July 1954, so is WAVE-TV proud again to be pioneering local color telecasting in Kentucky.

Set distributors indicate that as of May 1, 1963, there are approximately 15,000 color TV sets in use within the coverage area of WAVE-TV.

Response of the viewing public to WAVE-TV's local color efforts has been most gratifying. Our telephone comment sheet each day carries dozens of favorable comments and inquiries about our color efforts. Dealers—many of them outside the Louisville metropolitan area—have voluntarily called us to report the color quality to be excellent.

WAVE-TV at the present time makes no extra charge for showing color film.

In summary, we are very optimistic about the future prospects for color TV business. We recognize that color development requires leadership, and we are proud to be the one to offer this leadership in Kentucky and Southern Indiana.

FIG. 6. Scene from "Morning Show" a live, daily half-hour color program.

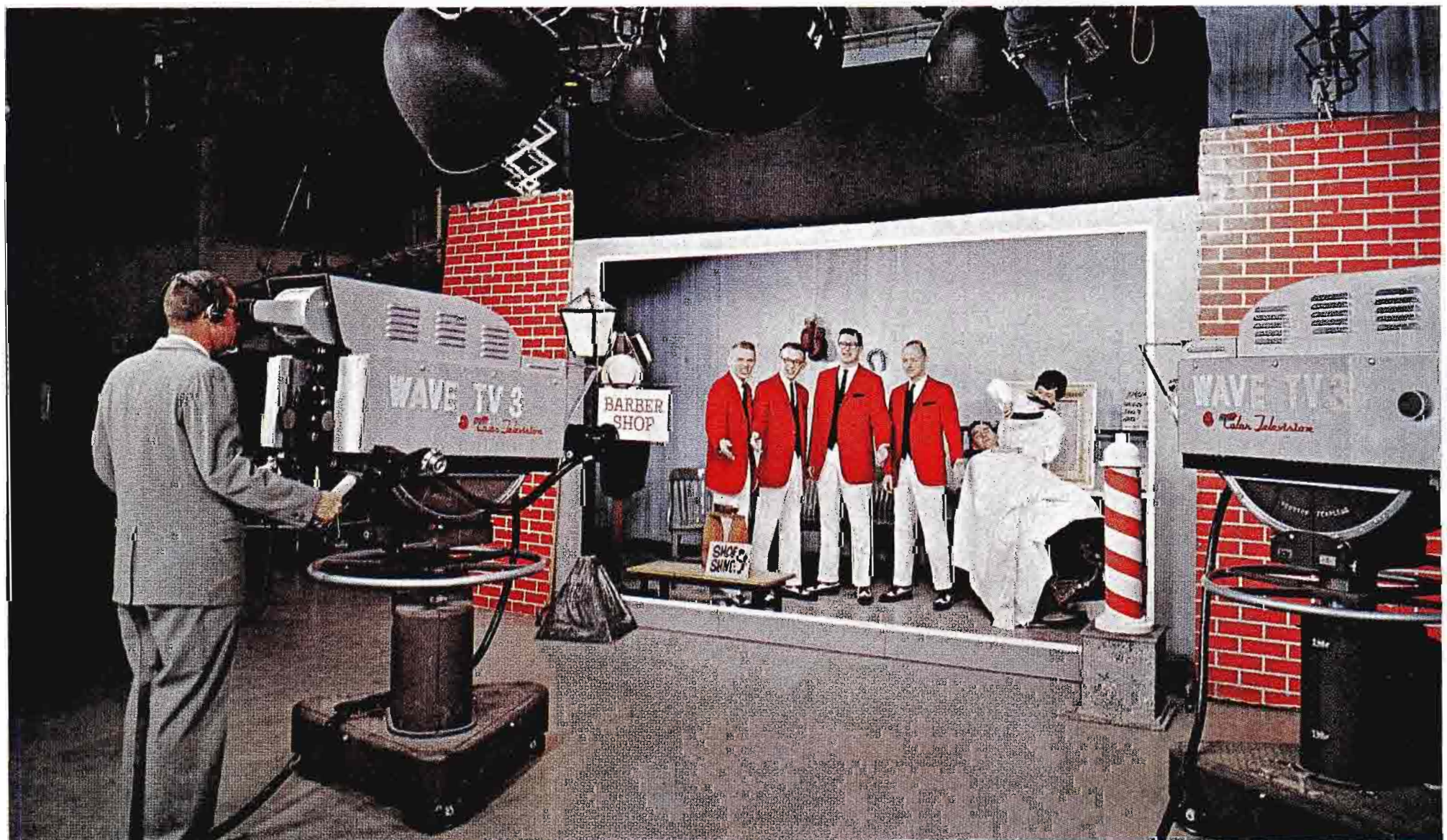

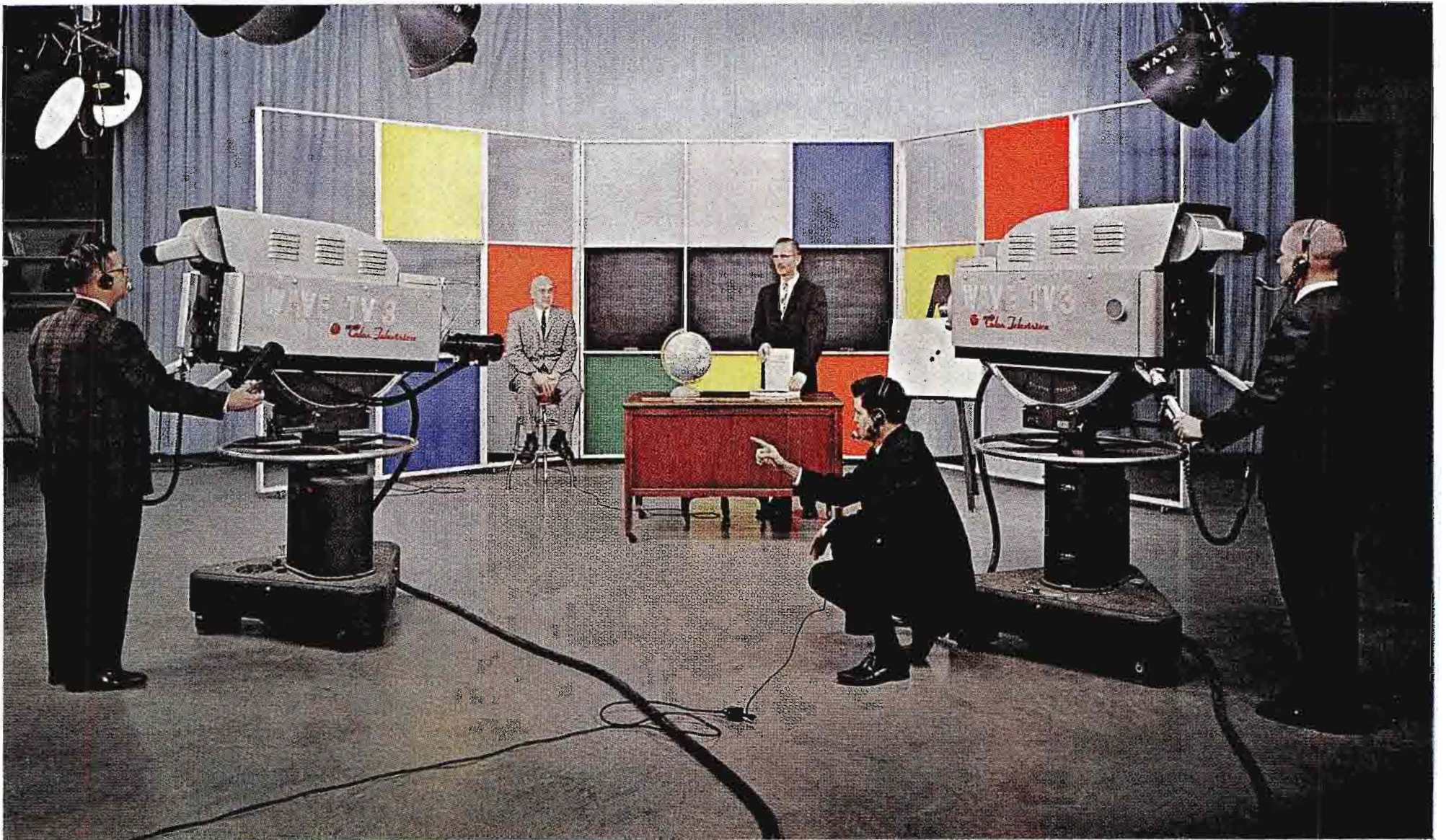

FIG. 7. Color program "University" is produced weekly in cooperation with the U. of Kentucky.

Half of Local Originations Are in Color

by GEORGE PATTERSON, *Program Manager*

We have found that adding color to our live programs has indeed provided another dimension, a "fourth dimension," as some have called it. This, in turn, has increased audience interest, a matter of obvious importance to all stations. Our experience indicates that there is no question that color will be an increasingly important factor in television.

THE MORNING SHOW, a live daily half-hour program featuring demonstrations, interviews, exercises, and local talent, has proved to be especially effective in color, with strong visual impact. We have started telecasting our 11:00-11:20 P.M. news, weather and sports program strip in color, which combines well with the TONIGHT SHOW following for a continuous two hour block of color every night, and, on several nights a week, when the preceding 10:00-11:00 P.M. hour on NBC is in color, provides a continuous block of three hours or more.

We videotape a number of our programs in color for telecasting on week-ends. These are taped during the week, when the participants are more readily available, and full technical crews are scheduled. KENTUCKY AFIELD, a program on fishing,

hunting and related outdoor activities uses studio demonstration combined with film.

Other color videotape programs are EXCURSION, a series dealing with the arts and cultural activities; and UNIVERSITY, which features, each week, a leading

faculty member presenting his specialty.

We have been carrying three half-hour color films weekly: "NORTHWEST PASSAGE" on Saturday afternoon, "TRUE ADVENTURE" on Saturday night, and "PLANET EARTH" on Sunday night.

FIG. 8. Daily news, weather, and sports program is done in color from 11 to 11:20 p.m.

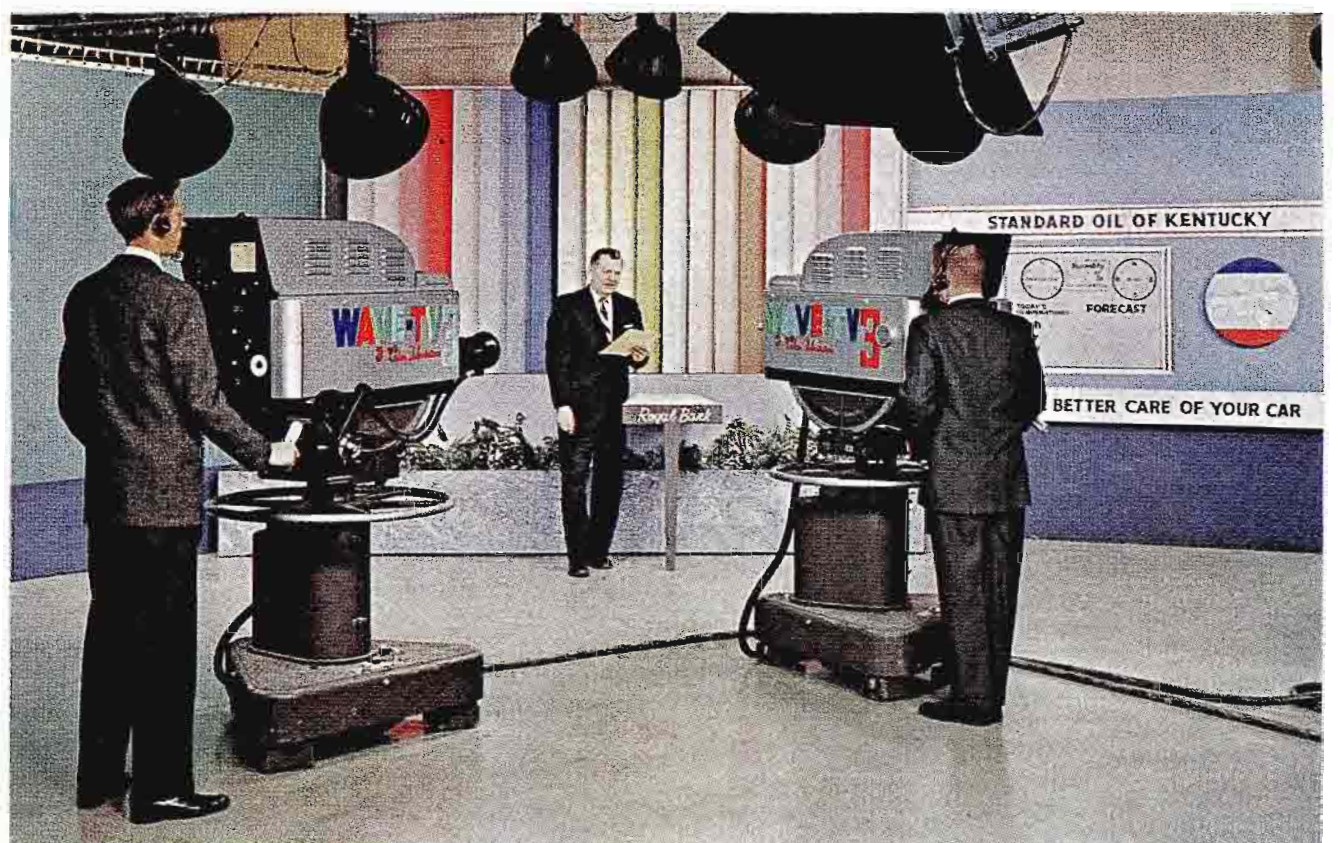

WAVE-TV Color Commercials

by RALPH JACKSON

Vice-President and Station Manager

At the present time, WAVE-TV is running color commercials for five accounts, totaling 26 commercials per week. Three of these are on film—Wrigley's Gum, Standard Oil, which sponsors the weather three nights a week, and Jerry's Drive-Ins. Swiss Cleaners is on videotape—color being chosen to show draperies and pillows to best advantage. Six live color commercials for Royal Bank are done each week on the 11 p.m. news.

Two other color commercial advertisers recently completed schedules—live V. C. Glass Co. commercials for Mohawk carpets, and film commercials in the "Northwest Passage" series for RCA color TV sets, with local dealer tags.

Techniques of airing color commercials, WAVE-TV Production Department has found, are not basically different from

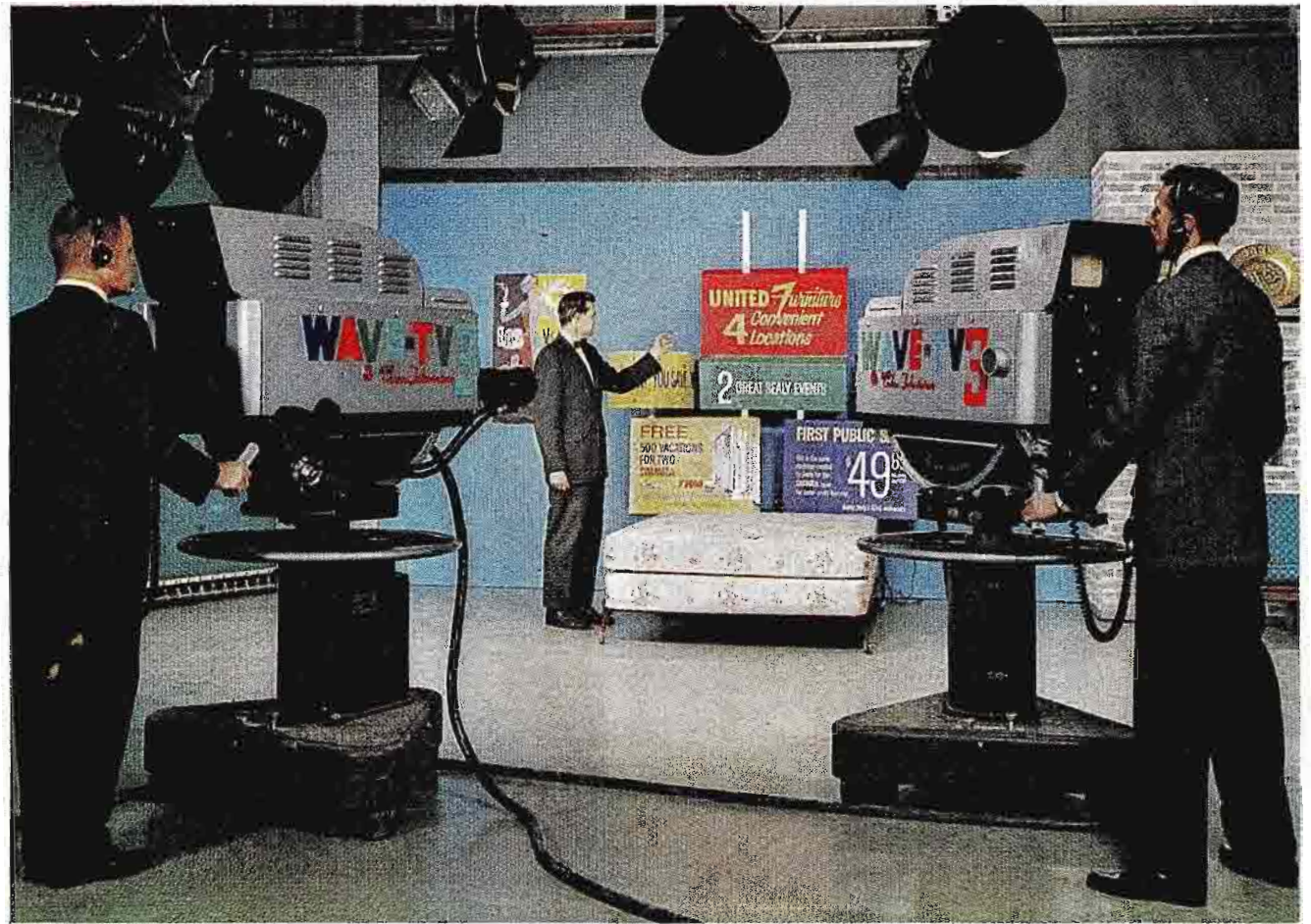

FIG. 9. Typical color commercial produced by WAVE-TV.

those for black-and-white commercials, but there are a number of departures which color has brought.

The results in monochrome as well as color must be kept in mind when planning. Clothing, for example, should not have two pastel shades together, or be in a hard finish, or be all-white—else both the color and black-and-white pictures are thrown

off. Approximately fifty per cent more lighting is required for color. All scenery sets have been repainted for color. Frequently colorful objects are added to brighten up plain sets, for example, sports scoreboards now use team insignia in color.

The clients that have used it, report that color adds to the effectiveness of their commercials.

WAVE Farm Program

WAVE, Inc. owns and operates a farm at Worthington, Ky., 13 air miles from the studios. The farm is used to demonstrate all phases of farm operation each Saturday, from noon to 1 p.m. This is often done in cooperation with the University of Kentucky and Purdue University Colleges of Agriculture.

The farm is no show place, but an efficient, practical working farm—a farmer's farm. For many years it has produced sheep, beef and dairy cattle, hogs, poultry, alfalfa, corn, wheat, barley oats, bluegrass, orchard grass and fescue. For the farm telecasts, the important crop of tobacco has been added.

In scope, FARM includes all categories of interest and value to farmers: Soils, machinery, buildings, fertilizers, insecticides, chemicals, livestock, crops, feed. Also home living and other subjects that concern the farmer in his everyday living.

The reason for FARM, and the producing farm that WAVE-TV operates, is to serve as completely as possible the station's large farm audience. Within this Kentucky-Southern Indiana area there are more than 150,000 farms with a population in excess of half a million.

To telecast a normal farm program, WAVE-TV uses two cameras. One is transported to the barns in the farmyard center by means of a specially constructed sled, hauled by a tractor. The second camera, equipped with a Zoomar lens, is moved about the farm in a small pick-up truck for covering the day's activities. Farm director, farm manager and the program's announcer travel by jeep from point to point.

In the farmyard center, technicians have constructed a central tv studio, with control panels, heavy wire for the electric load, and floodlights as well as sky light for bet-

ter lighting. This studio is 30 feet wide and 45 feet long and has large sliding doors on both sides of the building, making it easy for animals and large equipment to enter and leave the studio. Hinged doors at either end of the building permit the maximum amount of natural light to enter. The studio floor is partly concrete and partly crushed rock, the concrete strip allowing the camera to move evenly.

The station's mobile remote unit handles switching and camera control at the farm. One of the farm's silos is used as a microwave-relay tower to send the signal back to the studios.

In August, 1962, WAVE added a 500-acre tract for use in its TV Farm Show. This tract will be used in connection with a model automated cattle-feeding operation, now under construction.

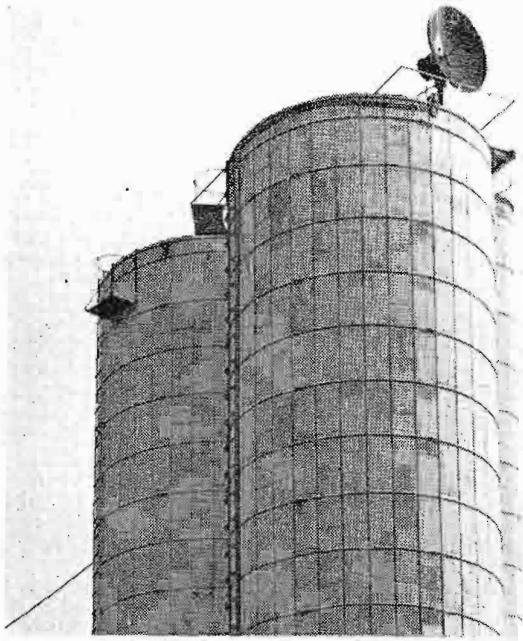

FIG. 10. Microwave antenna is mounted on silo at farm for link with TV studio.



FIG. 11. Farm program is produced live at station's own livestock raising and producing farm.



FIG. 12. One TV camera is moved about the farm in a pick-up truck to follow the actions.

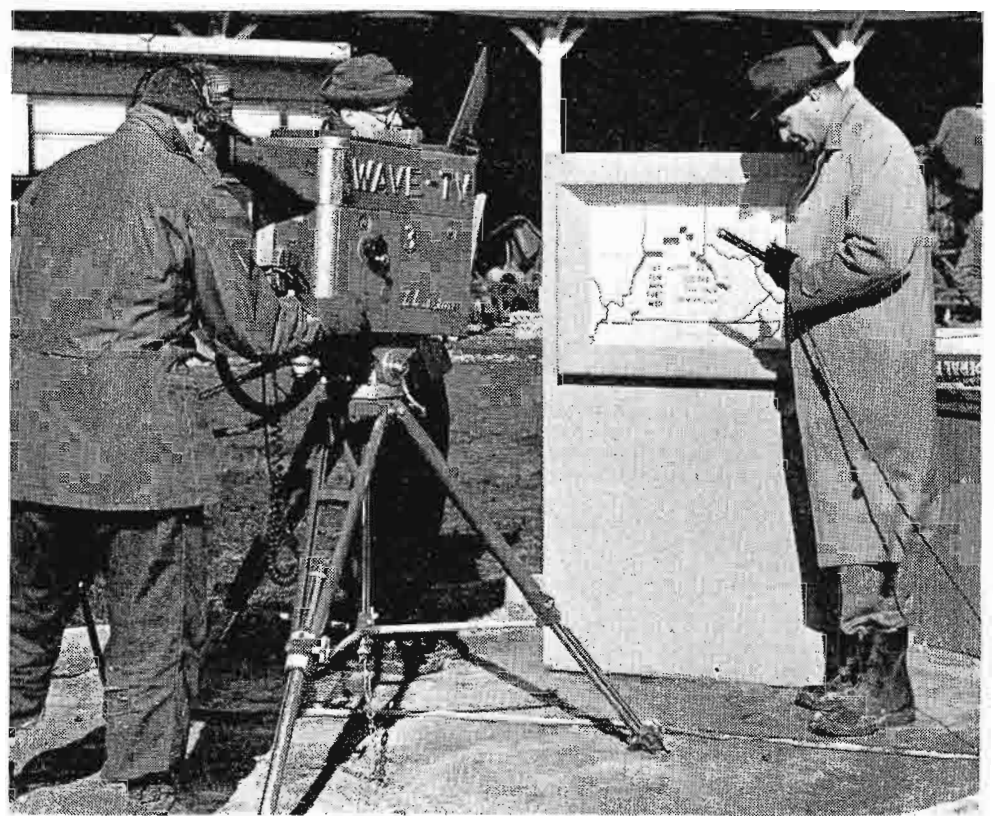

FIG. 13. Entire program is done live. Commercials and announcements are integrated into the program.



FIG. 14. Demonstrations include methods for raising chickens to become big, healthy profitably marketable poultry.



FIG. 15. Floor plan layout of new building.

Technical Equipment Facilities

by WILBUR HUDSON
Chief Engineer

The layout of the studios, control rooms, and technical facilities in the new building for WAVE and WAVE-TV were a culmination of years of planning on the part of the engineering staff, seemingly endless hours of discussion with other departments, and visiting of new plants.

The WAVE, Inc. Board of Directors had determined that WAVE-TV would go to full color—live, film, tape, and, of course, NBC network. Not only has this been accomplished, but room for future expansion has also been provided.

No Master Control

WAVE stayed away from a master TV control. There are two control points, one



FIG. 16. WAVE-TV Chief Engineer Wilbur Hudson (standing) at audio console with Louis Lau, personnel supervisor. This dual console is one of a long list of equipments designed and constructed by the WAVE engineering department. Panel at left makes possible switching any one of six microphones to the input of each BA-21A preamp. The output of the mixers feed into BA-23A program amplifiers.

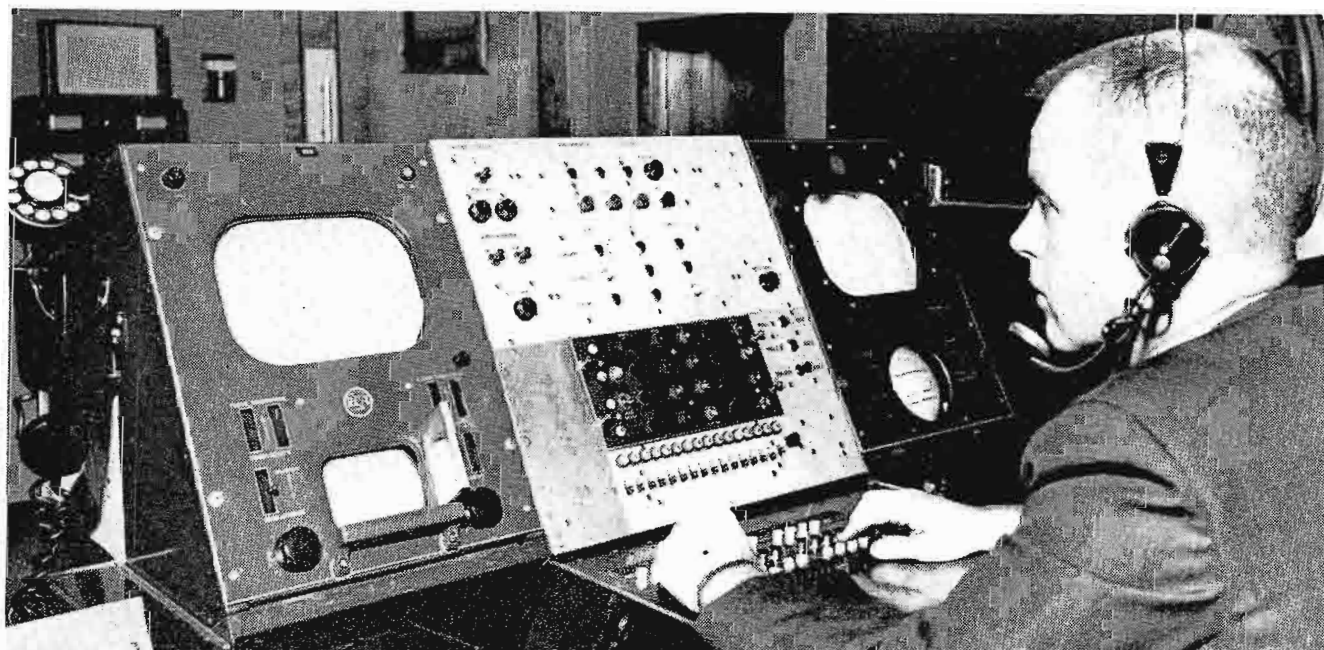
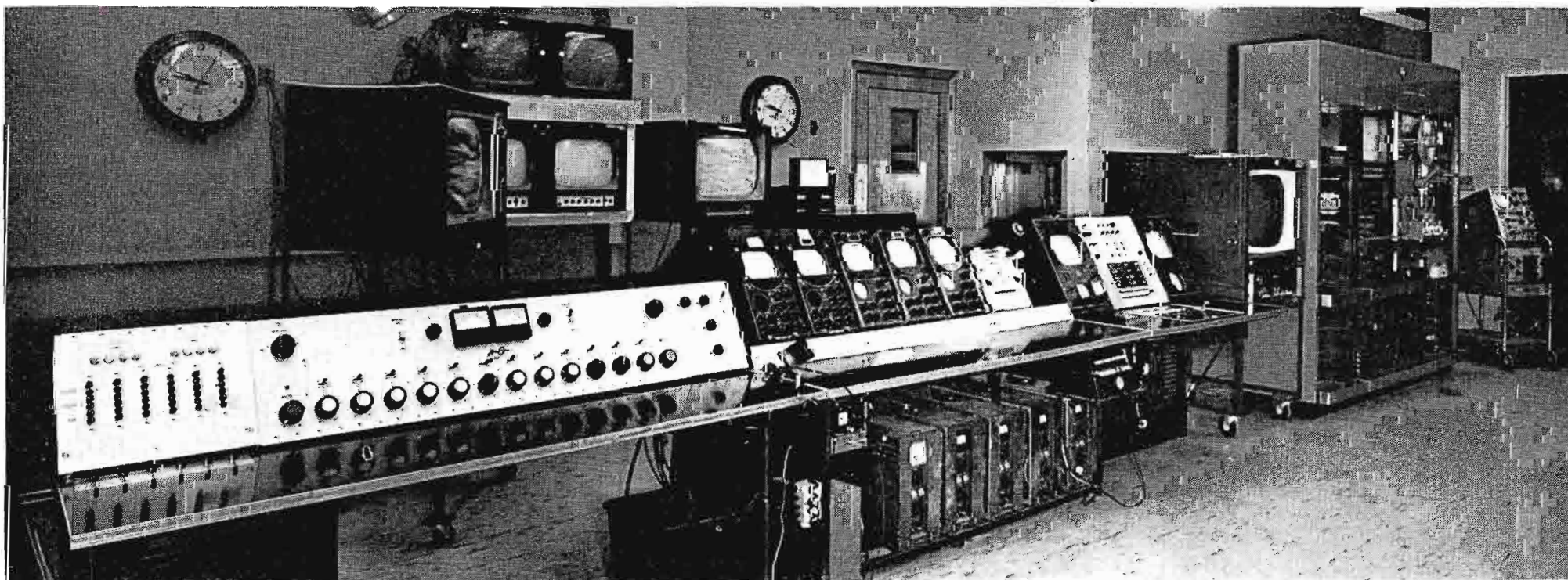

FIG. 17. WAVE-TV engineer Norman Preston at video switching position, which controls two of outputs from switcher. Panel in front is a duplicate of that in studio control booth. Most TV taping is handled from this control point.

being a booth from which both studios can be visually observed. This is the main control point. Four outputs of the 12 by 6 relay switcher appear at this point, as well as remote control of film, video tape, and audio. This booth is soundproofed from the equipment area—which is the second control point.

Facilities in the equipment area are a duplication of those in the main control booth, with the exception that the remain-

FIG. 18. WAVE-TV equipment room, showing audio switching console, two TK-31, and three TK-11 camera controls. Also power supplies, video switching console, and film controls. At far right is TRT-1A TV Tape Recorder, with color monitor. This area is used as a secondary control point during taping and rehearsals.



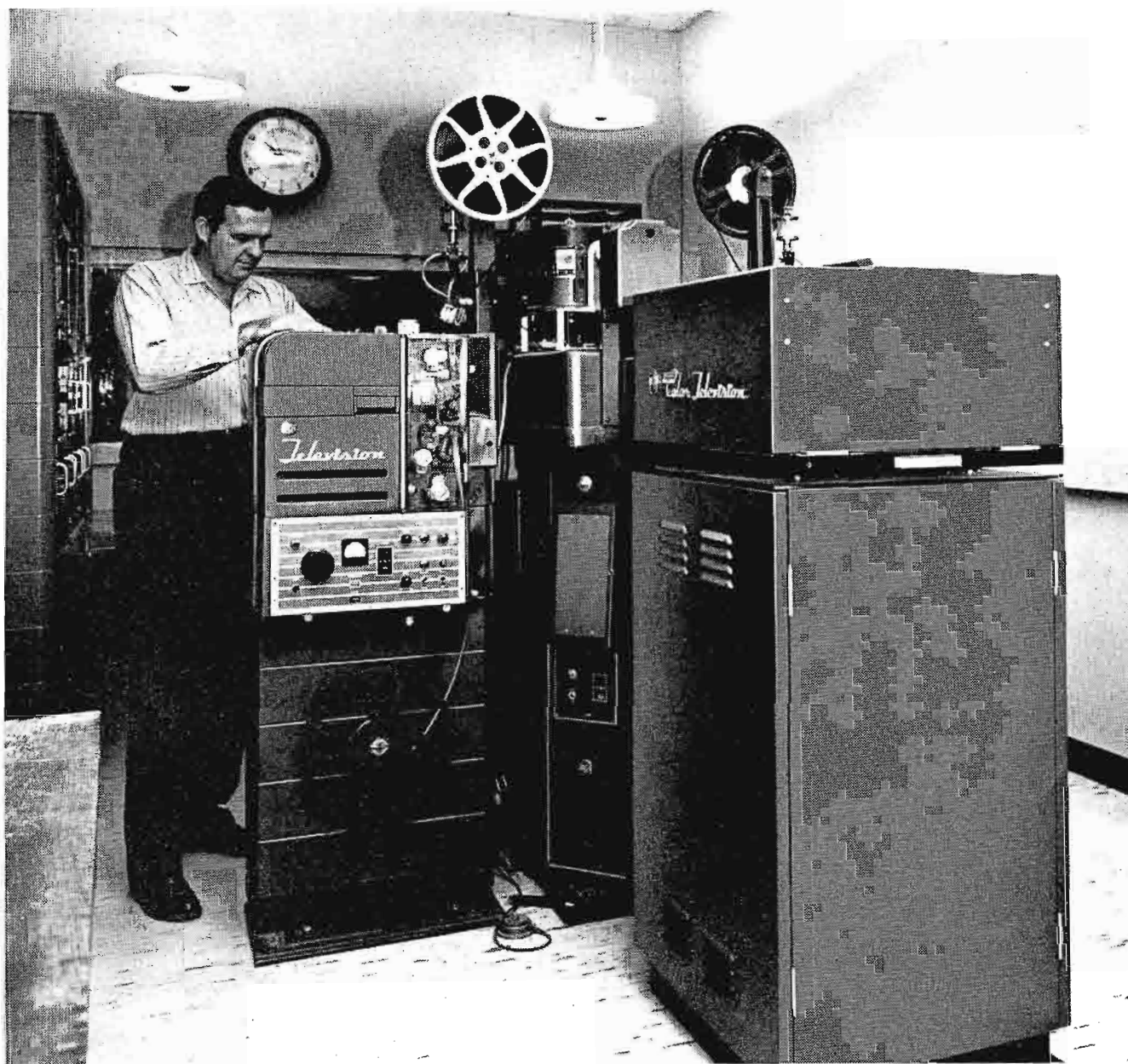

▲ FIG. 19. WAVE-TV film projector room, showing TK-26 3-V Color Film Camera, TP-6 16mm Projector, TP-15 Multiplexer, and random select projector shooting into a periscope. Fred Ray attends the projector.

ing two outputs of the 12 by 6 relay switcher appear here. Also in the equipment area are the 6 black and white camera controls.

This equipment area encompasses 950 square feet. Thirty standard BR-84 racks house equipment. The TRT-1A TV Tape Recorder is located here also.

All equipment wiring is through a slot in the floor into wire baskets on the ceiling of the basement. This one feature has proven its worth in accommodating necessary changes.

Film Room

Film is located in a room adjoining the equipment area. Here are concentrated the color controls for two live TK-41 Color Cameras and one TK-26 3-V Color Film Camera, as well as a TK-21 Monochrome Film Camera, and two TP-16 16mm Film Projectors, TP-7 Slide Projector, and TP-15 Multiplexer.

Custom Equipment

A considerable amount of equipment was custom built in the model shop by WAVE engineering personnel, and a very compe-

tent machinist. The two audio consoles are typical products of the shop. They are specifically designed to provide the features needed without having a number of left-over features not needed. These consoles use BA-21A, BA-23A and BA-24A amplifiers, around which the switching system is designed. They are dual-channel consoles, which adds to their versatility. Push button microphone selection makes 36 microphones available to either console without patching.

Training and Maintenance

The shop has been a valuable asset in many ways, one of which we are more cognizant each day, in training good personnel. After a man has built or modified complicated TV equipment and lined it up and gotten the "bugs" out, he has a pretty good idea of the why and wherefore of each circuit and has become somewhat of an expert in keeping it working.

In order to keep equipment well maintained, it is quite obvious a complete line of test equipment must be available. This has been acquired, and a regular schedule of maintenance sees that the overall system is well within tolerance.

Personnel, Scheduling, Training

Three engineers and a supervisor handle the complete television transmitter schedule. These men are regularly assigned to this job. Twenty-four full-time and two

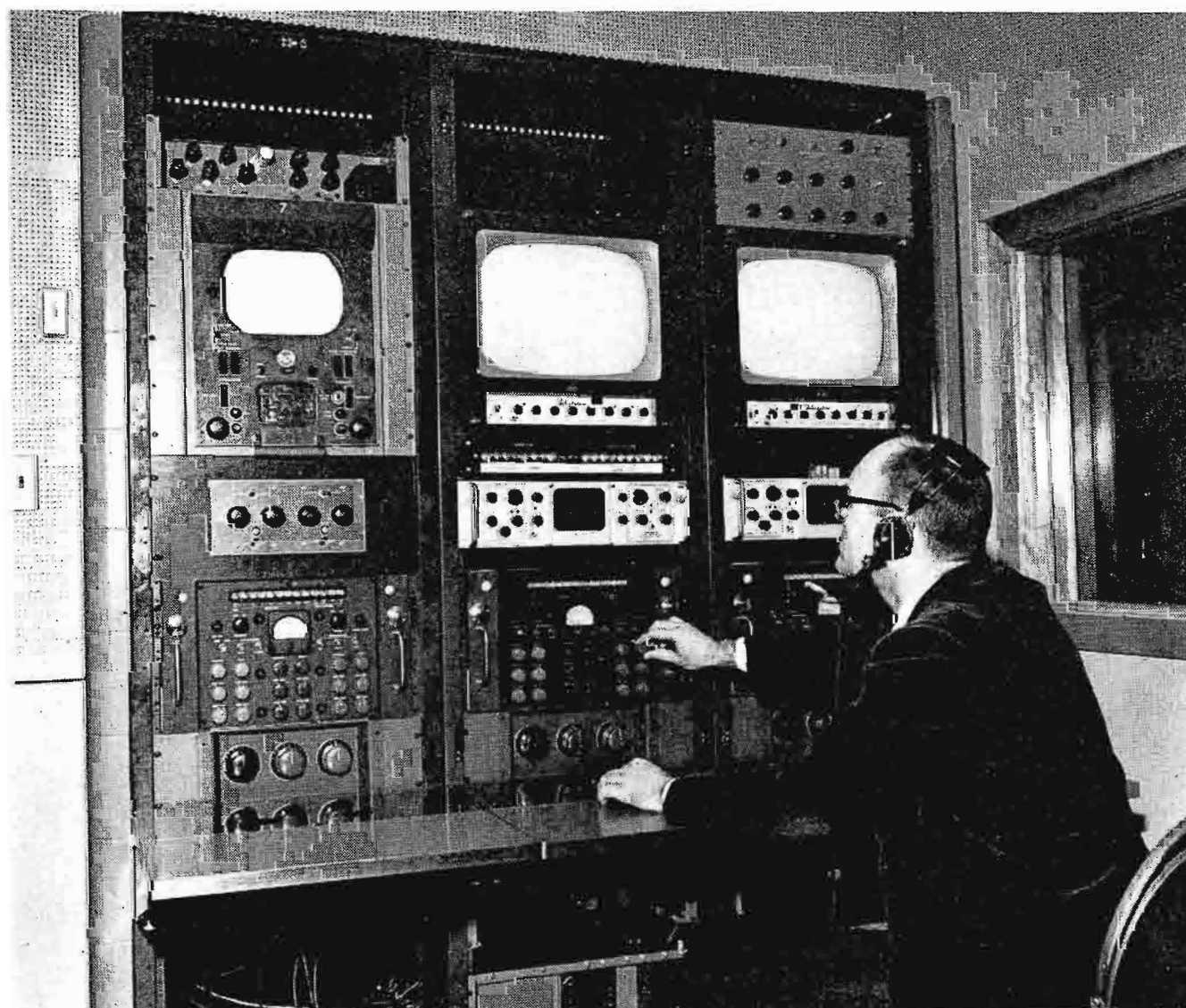

FIG. 20. WAVE-TV color control equipment for two TK-41 Live Color Cameras and one TK-26 3-V Color Film Camera. Engineer Jim Gardner is at the controls.

part-time engineers, along with two supervisors, handle all work at the studio, (AM and TV) and maintenance. One of the supervisors schedules all studio personnel.

WAVE, Inc. trains its engineers for the utmost versatility and flexibility. Most of the studio personnel will, during a month, work as cameraman, video man, TD, audio, (both AM and TV), be on a TV remote crew, and also handle some film and slides, as well as maintenance and possibly some new construction.

Many of these men can do one job better than another. This is known to the scheduling supervisor and he endeavors to put round pegs in round holes. However, it is necessary for everyone to be able to do a creditable job on anything—should it be necessary to re-assign him. For instance, sickness or vacation at the TV transmitter requires sending a replacement from the studio. We have several men who are qualified transmitter men. Incidentally every WAVE engineer holds a first class license.

It becomes obvious that careful engineer scheduling is required in order to have men available at the proper times and proper places, to assure efficient and economical operation.

WAVE AM Operations

Programs originate in two studios and an announce booth, totaling 895 square feet. The largest studio is approximately 28 by 22 feet. Two separate control rooms and an equipment room total 490 square feet. Dual channel consoles in each control room along with BQ-2A Turntables and a number of tape recorders furnish the necessary tools for production and airing WAVE programs.



FIG. 21. Roy Parris at audio console in studio control room. It's duplicate of control in equipment room. Both were built by WAVE-TV. All amplifiers are housed in cubicle under console. At left is RT-7A Cartridge Tape unit.

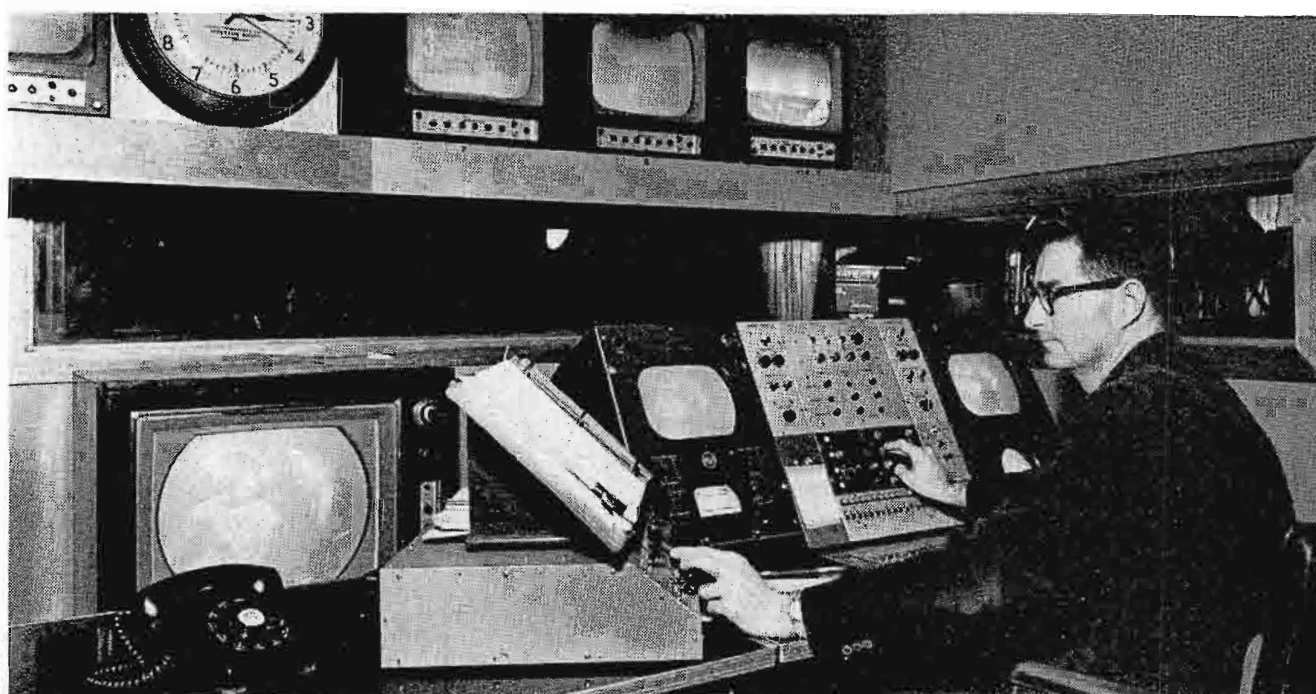

FIG. 22. WAVE-TV control booth, Robert Russell at video switcher. Panel between two TM-6 monitors contains controls for film and slide projectors. Other controls include genlock, network level, stab-amp, and video switcher outputs. Camera monitors are on overhead shelf. Narrow window allows vision into both studios 1 and 2 for director.

FIG. 23. WAVE-TV Model Shop. Here most of custom consoles were built under supervision of machinist Paul Raible.

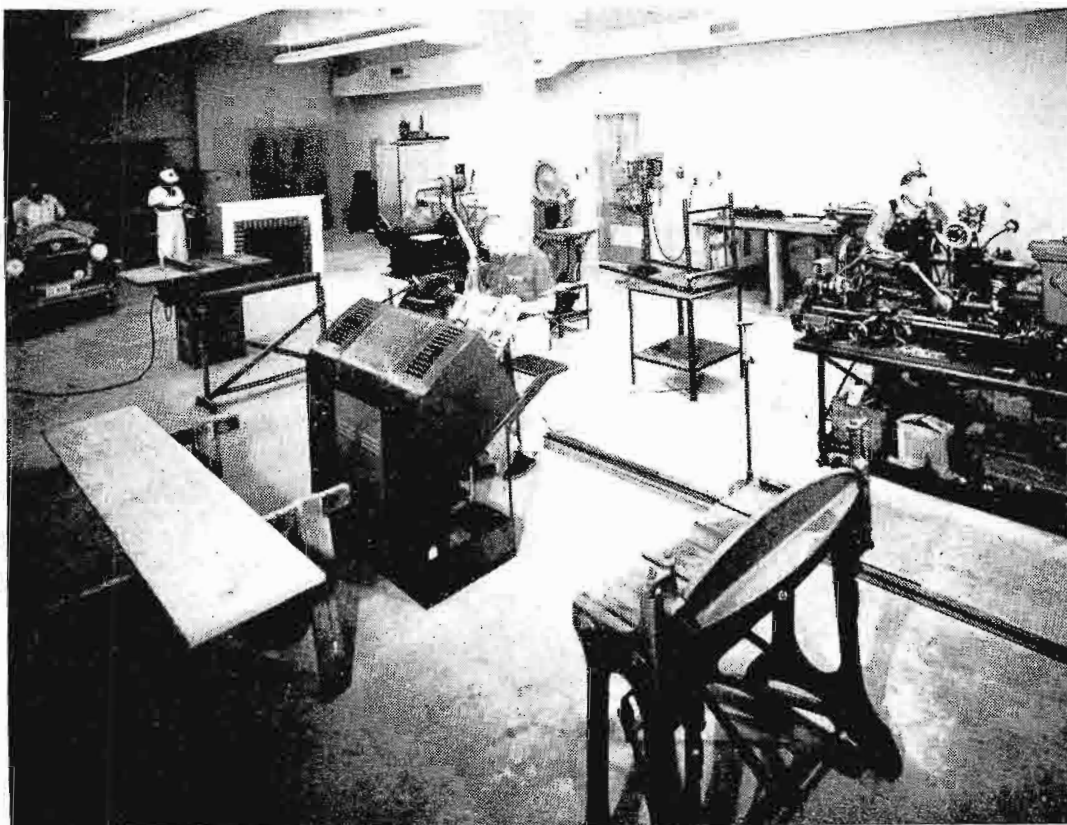

FIG. 24. WAVE-TV's Type TRT-1A Color TV Tape Recorder. At left, H. B. Holtman, assistant chief engineer; at right Robert Roth, maintenance supervisor.

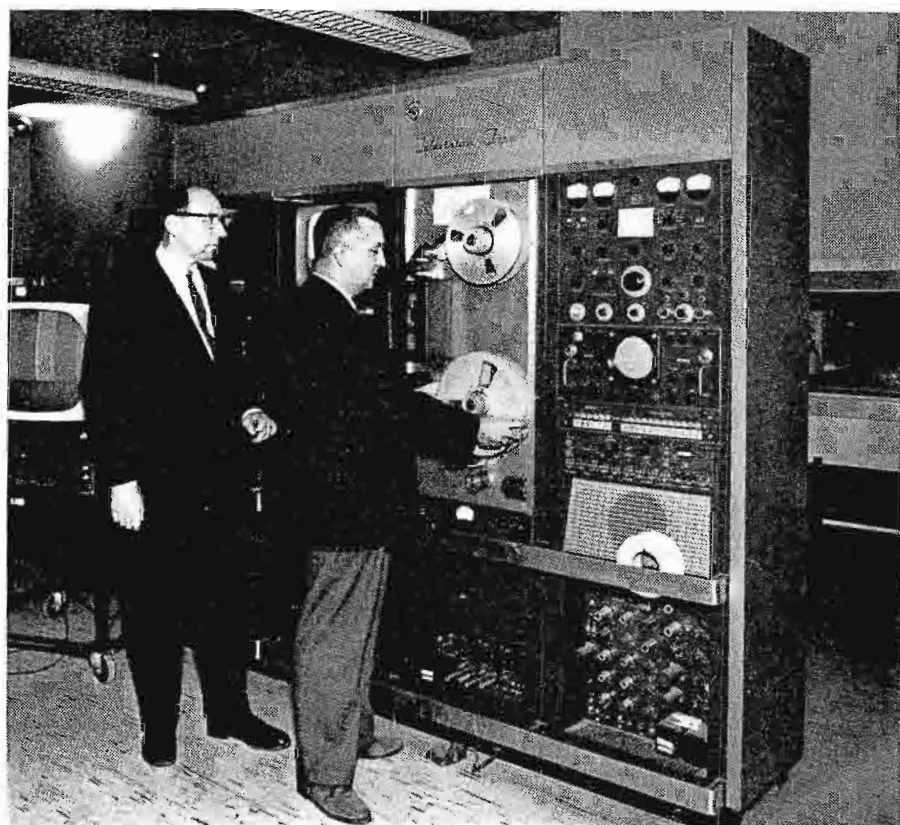



FIG. 25. TV Studio No. 1 is 45 by 65 feet with cyclorama permanent kitchen built-in and facilities for color and monochrome production.

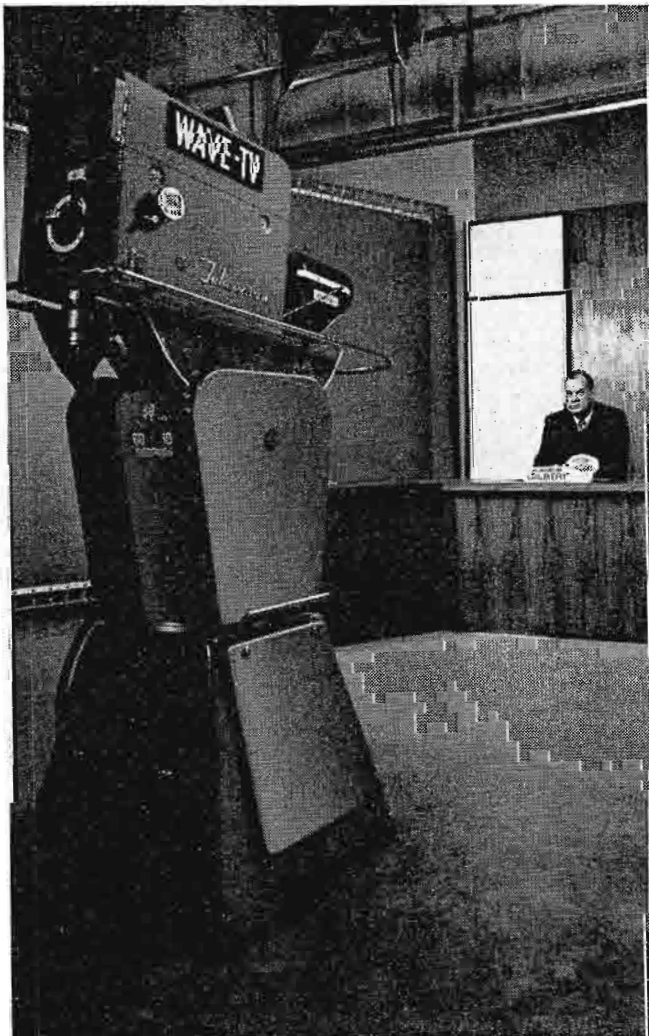

FIG. 26. Note camera atop the brick wall set, used for overhead shots of weekly amateur boxing.

TV Studios

Studio No. 1 is 65 by 45 feet with 22-foot ceiling height. Walls and ceilings are covered with a 2-inch blanket of glass wool which, in turn, is covered with white muslin. Over this is stretched $\frac{3}{4}$ -inch mesh chicken wire to protect it from damage. This is satisfactory and efficient acoustical treatment. Floors of the studio are smooth concrete with a special hardening agent added to the concrete to retard dust.

FIG. 27. WAVE-TV robot camera, focused here on Newscaster Livingston Gilbert, has lights in front and rear to cue the remaining time. This camera is remotely controlled by video operator.



A sound lock from this studio to the prop room makes possible bringing in cars, trucks, boats, and other large items for live display.

Two lighting rails on either side of the studio run the full length. On these are transverse rails 12 feet long, on which pantographs holding the fixtures are placed. This mobile system of lighting makes possible good lighting of sets, as the lights move with ease on the tracks.

After seeing lighting tubs in use at other stations, we have designed a version with four 1000 watt bulbs per tub. These will replace some of our present scoops on pantographs and will be equally versatile. We are of the opinion this "tub" type light will make possible flat, even light for color, with a lot less effort. Those working under

the lights prefer this type lighting to scoops and spots, as it is easier on the eyes, and makes reading a prompter much easier.

TV Studio No. 2 is 36 by 25 feet and treated in the same manner as Studio 1. Both studios are equipped for color and monochrome television productions.

Prop Area

Storage of props becomes a problem of considerable dimension. We feel this is under control at WAVE-TV, as we provided 6300 feet of storage adjacent to the studio. A ramp makes possible delivery trucks driving into the prop area, when necessary, and also is used to bring in other large props for telecasts. Another 15,000 square feet of space is available in the basement for dead storage.

FIG. 28. TV Studio No. 2, 26 by 35 feet, is equipped for monochrome and color TV.



Air Conditioning for New Building and Color TV

by **BERNIE HOLTMAN**
Assistant Chief Engineer

It was desired to have an efficient refrigeration system, requiring a minimum of maintenance and capable of rapid start-up during unseasonable warm spells that occur in Louisville during the winter months. In order to achieve this, coupled with low operating cost, and a measure of emergency back-up capability, the following features were included:

1. Individual fan-coil air handling units, eight in all, for various zones in the building.

FIG. 29. Compressor-Condenser-Chiller System. Six 30 h.p. compressors are associated with two 800,000 B.T.U. chillers, three compressors to each chiller. System No. 1 feeds treated water at 45 F through a closed circuit to the TV areas of the building. System No. 2 feeds the rest of the building.

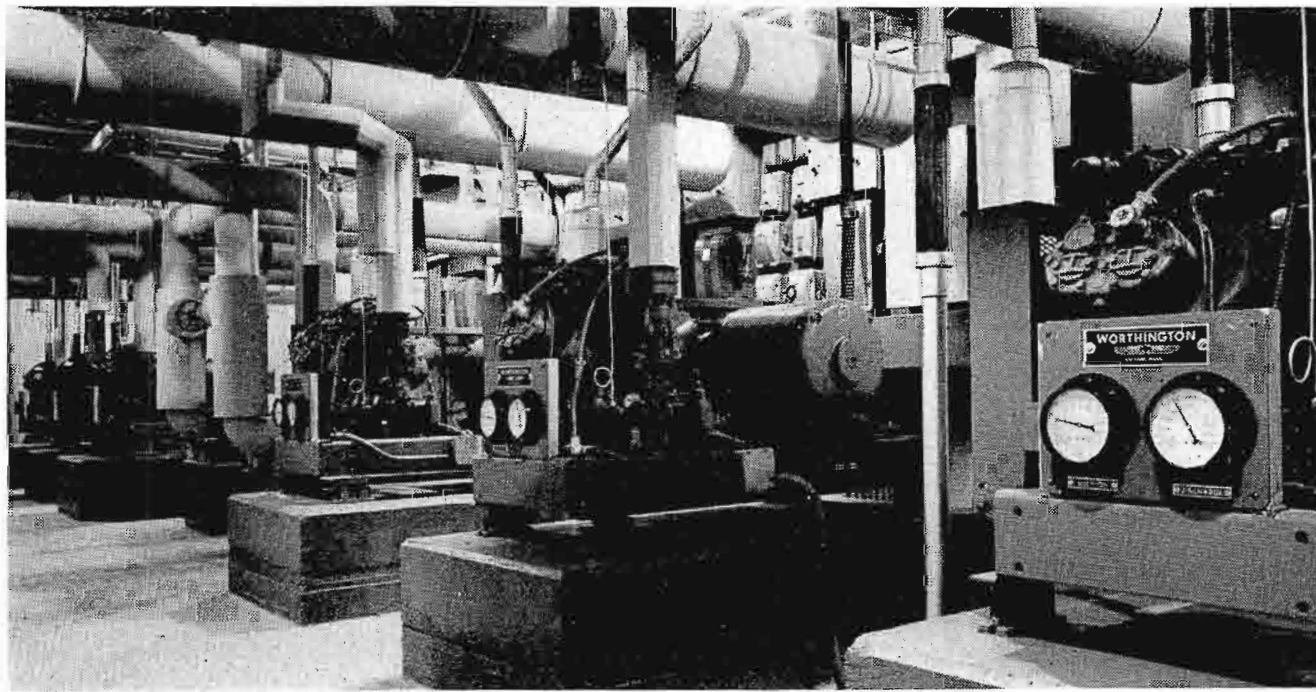

2. Roll-type media filters for each fan-coil unit.
3. Six compressors, each with an air-cooled refrigerant condenser.
4. Two identical chillers, each with a chilled water circulating pump.
5. All electronic control system.

Air Handling Units

The building is divided into eight zones, each having its separately-controlled fan/coil unit:

1. TV Studio No. 1 15,500 CFM
2. TV Studio No. 2 9,750 CFM

3. Radio studios & control rooms, newsroom 5,620 CFM
4. Music, film editing, lounge, dressing rooms, lobby 4,590 CFM
5. TV control, equipment & projection rooms 3,660 CFM
6. General offices 7,470 CFM
7. Art & props, carpentry & machine shop, electronic shop and storage 3,860 CFM
8. Future expansion area 4,000 CFM

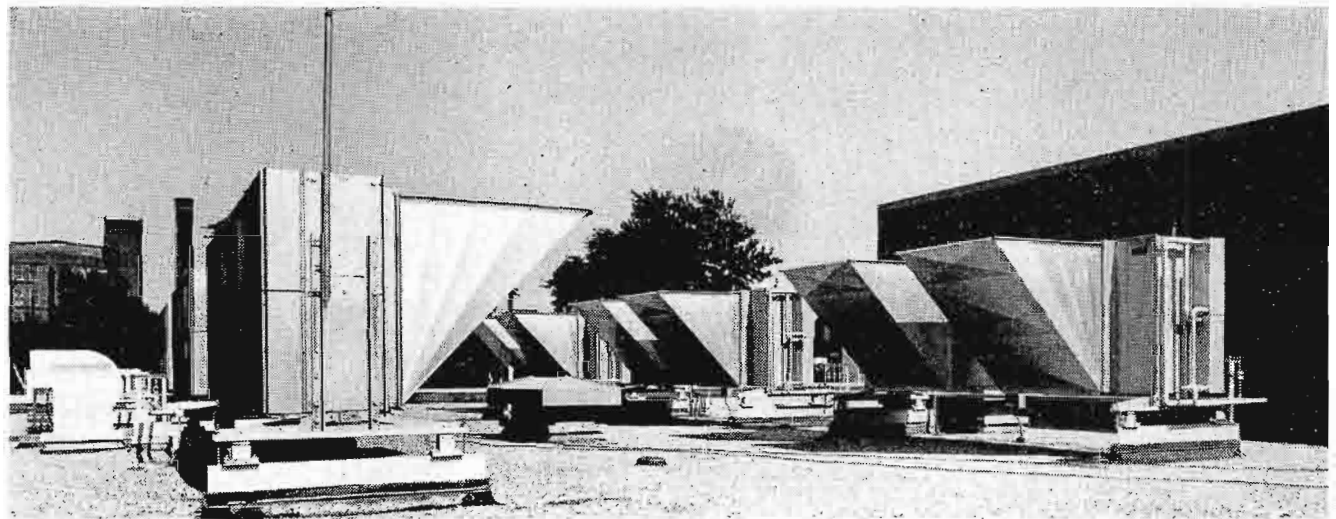

FIG. 30. Each compressor has its individual air-cooled condenser on the roof. No cooling tower is used. Each condenser has two 48-inch fans, belt-driven by one 3 h.p. motor. This system eliminates the problems of corrosion, algae control, water and sewer-tax costs, freeze-up protection.

Each of the eight zones has its own outside air intake and exhaust ducts, chilled and hot water coils, and control system. When a given zone is not occupied, its fan is turned off, thus reducing the overall load from the compressors or boiler. There is a central control panel in the electronic shop, as well as individual control stations.

Roll-Type Filters

The air filter in each fan-coil unit is of the roll-media type which automatically changes the filter media through the use of timer-controlled motors. A roll of media lasts from one to two years and the rate of change can be varied at will. This system

allows constant static drop across the filters which maintains system balance, and eliminates periodic manual changing and disposition problems of throw-away filters. It has been trouble-free and economical.

Electronic Controls

Each fan-coil unit feeds a hot deck and a cold deck, which feed supply ducts to the individual rooms. Each supply duct has a mixing damper which proportions the air from each deck, driven by a transistorized motor assembly controlled by a room

thermostat. The stat sensing element is a coil of high-temperature-coefficient wire, which is an arm of a bridge circuit. Room temperature is controlled by a variable resistor. There are 47 individual transistor-motor controlled zones divided among the eight air handling systems.

The temperature of the hot and cold decks of the zone units are controlled by outside air, acting through tube-type amplifiers upon electric positioning motors which control circulating water valves and air dampers. Maximum use of outside air is made for cooling, through "economizer" duct and damper arrangements, before refrigeration is called for. The controls for both heating and cooling throughout the building are all-electronic, no air compressor, tubing or pneumatic devices being employed.

Color TV Studio

The TV studio air conditioning was designed with ducts and grilles sized to handle a future heat load expected to be 50 watts per square foot for color, but with present refrigeration and blower capacity of 30 watts per square foot. It was found

that the 30 watt capacity was adequate when color operation commenced, using the 4415/16 image orthicons in the color cameras, with light levels of 250 to 400 foot-candles.

AM Radio Transmitter

In 1933, WAVE went on air with power of 1000 watts from a 239-ft. tower atop the Brown Hotel. Power was increased to 5000 watts in 1940 and operations were transferred to the new transmitter building in Jeffersonville, Indiana. In June 1955, WAVE installed a Type BTA-5H 5KW High Fidelity AM Transmitter, which is

currently being employed. The older transmitter, with RCA Type 250-K exciter and 1-G Amplifier, is being used for standby and Conelrad operation.

A brick structure 41 by 30 feet houses radio transmitting equipment. Two towers 250-foot high are arranged for day and night patterns. The transmitter equipment is remotely controlled for both daytime and night operations.

TV Transmitter

In 1953, WAVE-TV switched to Channel 3 with ERP of 100,000 watts, operating from a new 600-foot tower at Bald



FIG. 31. AM radio transmitter building in Jeffersonville, Ind. Note 2-tower array, at right and left. For normal operation, transmitter is remotely controlled from downtown Louisville studio.

FIG. 32. WAVE Radio transmitter room with BTA-5H Transmitter. Two cubicles on left house phasing units for day and night patterns. An older transmitter (not seen) serves as standby.

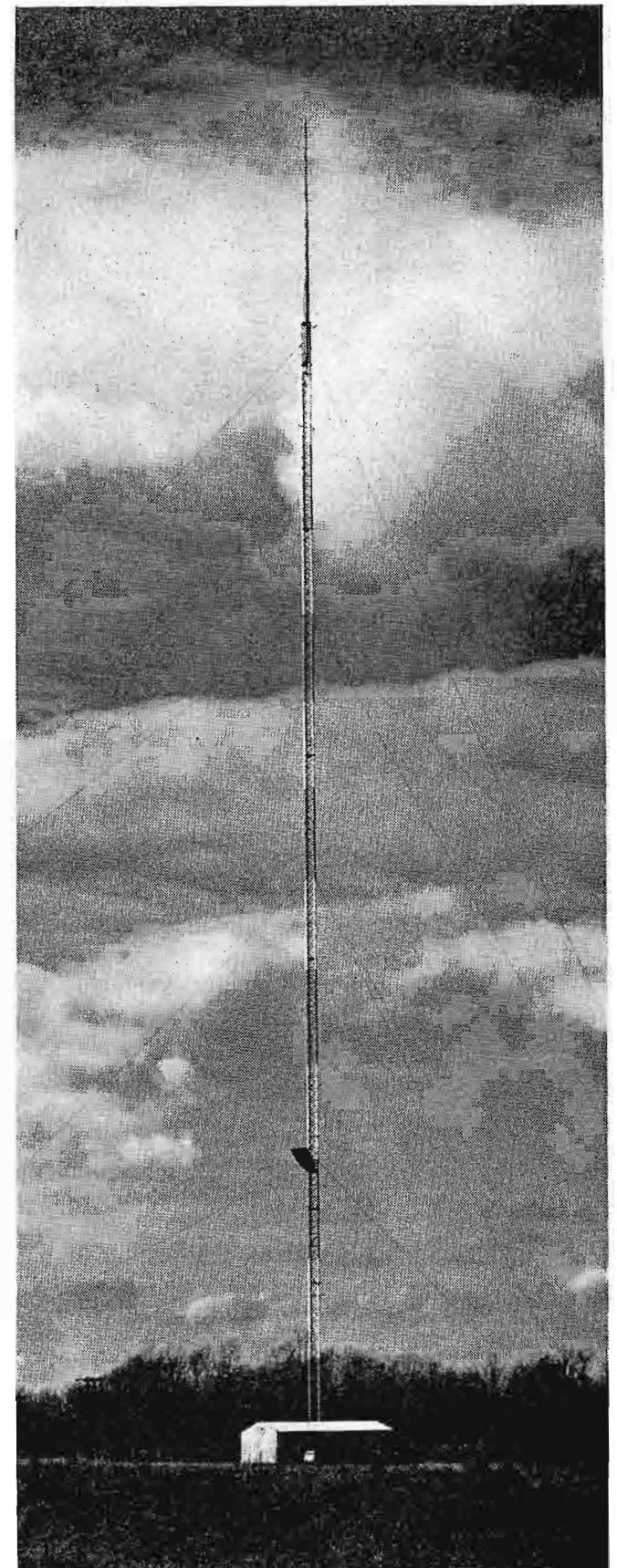
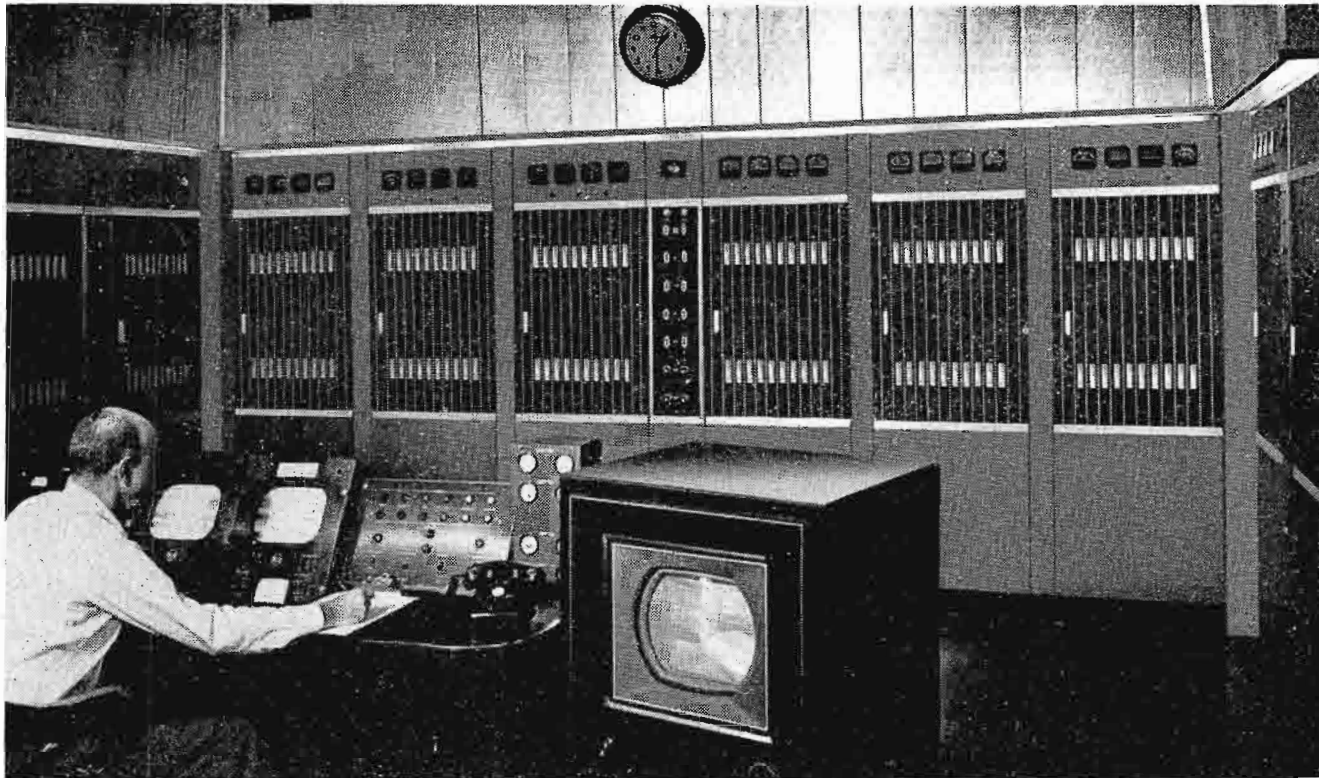

FIG. 33. WAVE-TV transmitter site 500 feet above Louisville. The tower and TF-6AL Antenna overall height are 600 feet. The location, Bald Knob, Indiana, is the highest site in the Louisville area for television towers.

Knob, Indiana (north of New Albany) on a hill 1000 feet above sea level. This move together with the power boost increased WAVE-TV's coverage by over 65 per cent.

The transmitter building has been designed for maintenance-free operation. It is a small 35 by 60-foot all-aluminum structure. Operation is efficient and economical. For example, exhausted hot air from transmitter equipment is piped back to heat the building.

An RCA Type TT-25BL 25KW TV Transmitter is used in combination with a 100-foot Type TF-6AL 6-Bay Superturbo-stile Antenna with 6.7 gain to achieve effec-



mobile unit. Back at the studio a rotatable antenna is employed to receive signals from this mobile unit.

At the studio, in the courtyard of the new building, a 135-ft. tower supports two microwave dishes. One is used for receiving signals from the farm and the other from the mobile unit. A passive reflector on the tower is used for transmitting the video signal from the rooftop dish on downtown Louisville building to the transmitter at Bald Knob—a distance of 10 air line miles.

FIG. 34. WAVE-TV Type TT-25BL TV Transmitter, located atop Bald Knob, north of New Albany, Indiana. Bob Dickerson is at the controls.

tive radiated power of 100 kilowatts. The 600-foot tower is located on a hill which is 914 feet above average terrain.

Microwave System

WAVE-TV has installed four microwave systems. Between studios and transmitter, A TVM-1A RCA 1 watt 7000 mc system is the regular channel. In addition, a standby system of 10 watts on 2000 mc is available.

Between studio and the farm, an RCA 0.1 watt system is installed. At the farm, camera cables and video cables are installed on overhead messengers so that programming to and from the mobile unit can be accomplished with ease. Also, on occasions the fourth microwave system (portable) is used in a double hop to program from remote areas of the farm.

The portable microwave system is used in conjunction with the WAVE-TV remote

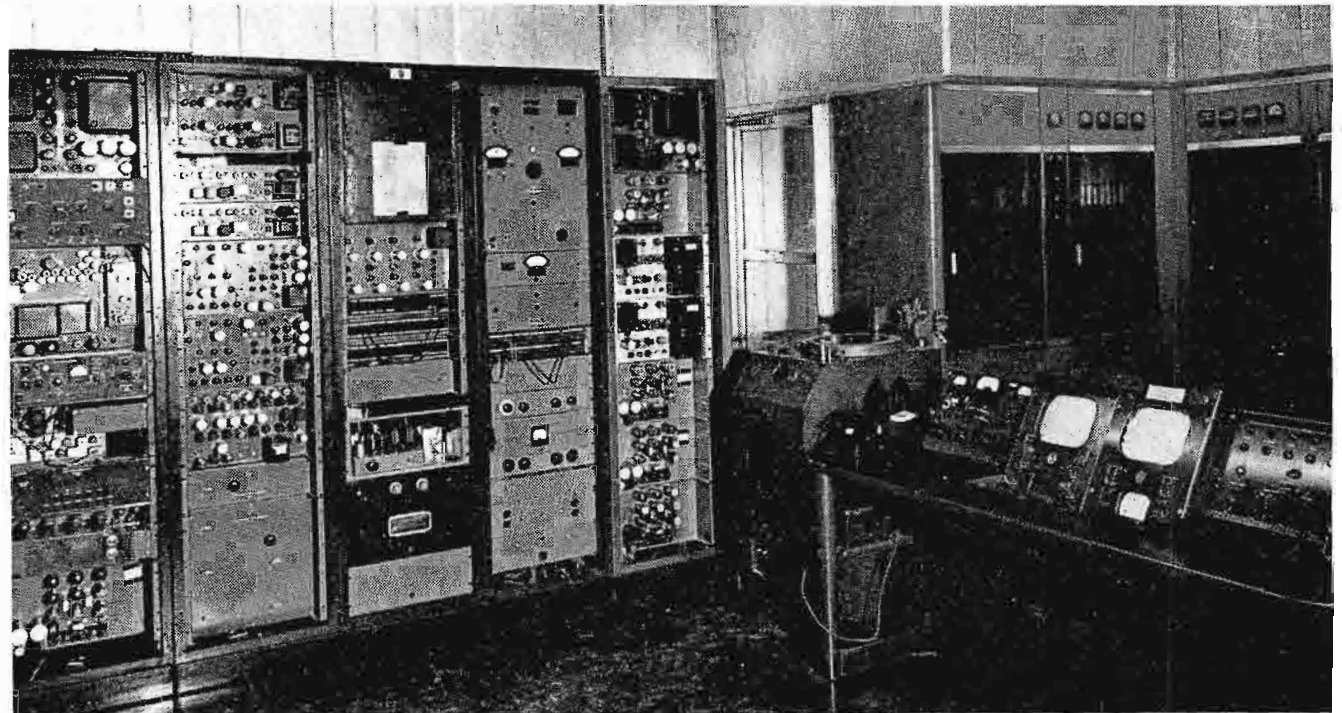

FIG. 35. WAVE-TV transmitter room, showing the control desk and racks of input and monitoring equipment.

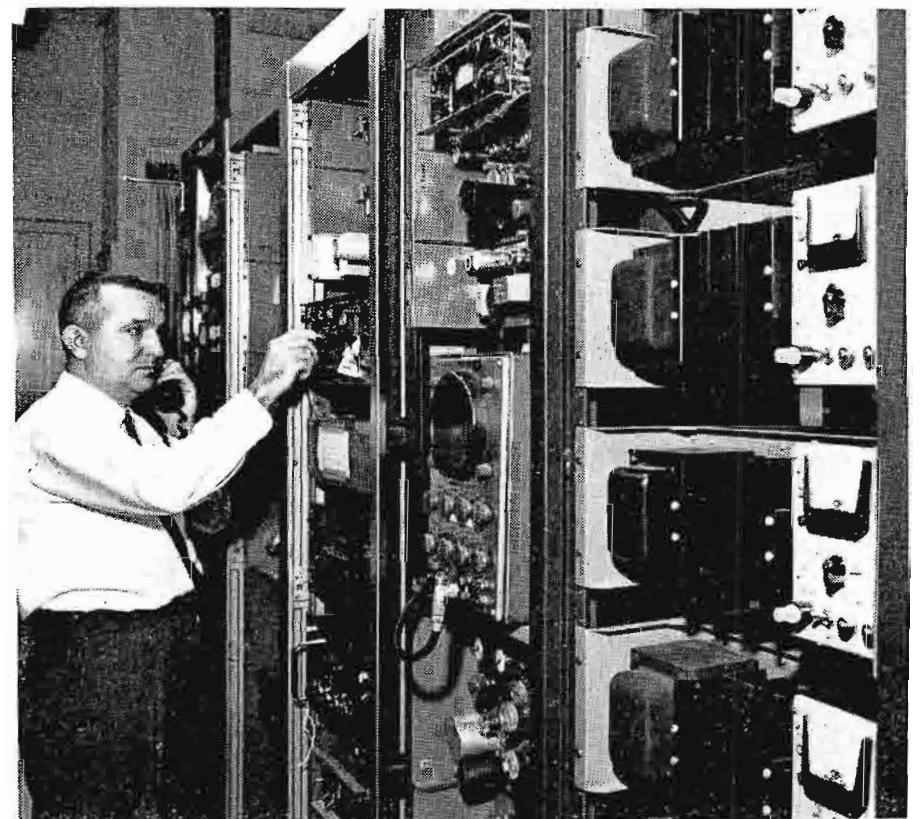
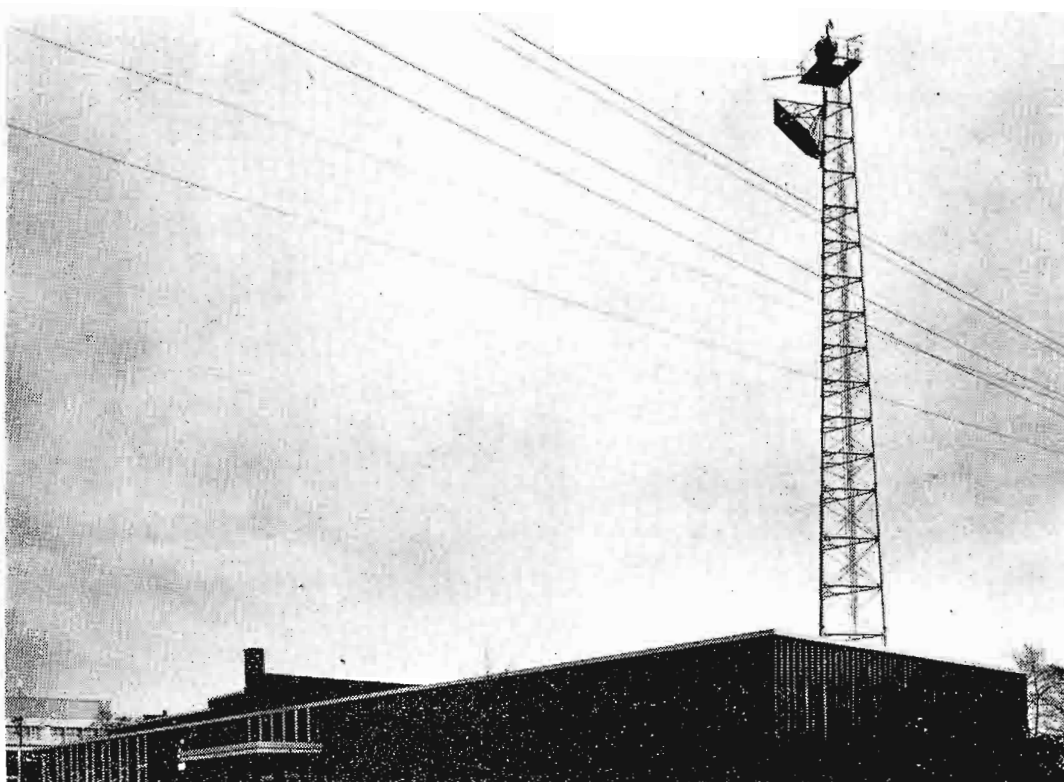

FIG. 36. Self-supporting 135-ft. microwave tower. Note two receiving dishes on platform—one fixed, and one rotatable. The reflector handles a 7000 mc STL microwave and also a 2000 mc STL, both with roof-mounted antennas.

FIG. 37. An RCA STL microwave unit is adjusted by Robert Roth, maintenance and equipment supervisor in Louisville studio building. Rotatable antenna on tower is also controlled here.



WRVA INSTALLS NEW RADIO FACILITIES

Virginia's Most Powerful Voice Rings Loud and Clear From New 50-KW Ampliphase Transmitter

by R. W. RAABE, *Chief Engineer*

WRVA-Radio began broadcasting with a 1000 watt transmitter in 1925 as the highest powered station in Virginia. A typical community operation, it presented programs representative of religious, civic, cultural and entertainment life of the South. Owned and operated by Larus and Brother Company, its policy was stated by the late William T. Reed, Sr., then President, at

the dedication, "To render service to Richmond and Virginia."

Today, still Virginia's most powerful radio station, WRVA is now more powerful and clearer than ever thanks to its new RCA BTA-50H 50-kw AM Ampliphase Transmitter, and the new BTF-20D 20-kw FM Transmitter, with an effective radiated power of 200 kw.

The two new transmitters are housed in a picturesque colonial mansion set upon a bluff overlooking the historic James River some 50 miles up stream from Jamestown, the first permanent English settlement in America.

Together, these two new transmitters occupy less space than required to house the old 50-kw transmitter, which is now used as a stand-by unit.

Because of their modern, compact design, the new RCA transmitters were installed without the necessity of making any alterations to the existing 50-kw veteran of 23 years, or additions to the existing building.

Program Services

Through the years, the station has broadcast from 72 of Virginia's 98 counties and from 28 of its 34 cities. In the early years, it began broadcasting services of the Old

FIG. 1. A down-the-front view of the new RCA 50H with the old 50 kw transmitter in the background on the other side of the front-to-rear center corridor of the building. The exhaust duct exits through the upper half of a window

at this end of the transmitter. A 30-inch fan at the exhaust point is provided to permit additional air movement during the hottest summer days. With this arrangement there is always more than adequate cooling available.





FIG. 2. WRVA-Radio transmitter building of Colonial architecture and re-enforced concrete and brick construction throughout overlooks the historic James River.



FIG. 4. Alden Aaroe, Director of WRVA Special Services, at master control.

Dominion's churches and has continued this down through the years. In its list of services to education, WRVA-Radio is proud of its "School Closing Notices" broadcast each winter. Superintendents from county and school districts are assigned new codes each fall so that they may call the station when the snows come to have their schools officially closed by the station.

In its service to youth, the station originated the program "Scholarship Quiz" which featured, annually, a 13-week broadcast-visit to Virginia high schools with sen-

iors vying for University of Richmond scholarships.

High on its list of services to the people of Virginia is its service to Virginia farmers. A survey by the Virginia State Department of Agriculture revealed that WRVA-Radio was the top-ranked station by the State's farm population when it came to tuning in farm market reports, farm weather reports, etc.

Three Power Sources

The three high-voltage transformers for the BTA-50H are mounted in the basement of the transmitter building directly beneath

the transmitter. The additional switch gear is mounted on the wall adjacent to the high voltage transformer cage. Transformers for the BTF-20D are stacked and also mounted in the basement beneath the FM transmitter.

Power for the entire transmitter building is furnished by any one of three sources. The Virginia Electric and Power Company has two services (from Richmond and Williamsburg) brought to an automatic changeover switch at the entrance to the transmitter property. A 200 kw Cummins diesel generator in an adjacent building is on stand-by duty. Sufficient power can be derived from the stand-by unit to operate both transmitters at full power, plus all auxiliary building services. This generator is entirely automatic in operation thus reducing loss of air time in the event of commercial power failures.

Built-In Cooling

Both RCA transmitters are cooled by internal blowers. The blowers are mounted on the concrete floor inside their respective units and the warm air is transmitted through sheet metal ducts to the outside of the building. Thermostatically controlled louvres allow the use of some of this heat to warm the working areas on the main floor of the transmitter building.

FM Transmitter

WRVA-Radio is presently duplicating its AM programming on FM with a 200-kw ERP signal. Since WRVA's 1B clear-channel pattern is a fulltime figure 8, the non-directional FM pattern does an excellent job of supplementing service in the null areas of the AM service. To date, excellent FM reception reports have been received

FIG. 3. Immediately below the new RCA 50H, in the basement, is mounted the switch gear associated with the transmitter. To the left of this are the three high voltage transformers enclosed within a heavy wire grating. Mounting this switch gear in the basement has proven entirely practical since the necessity to manually operate these breakers is very rare.

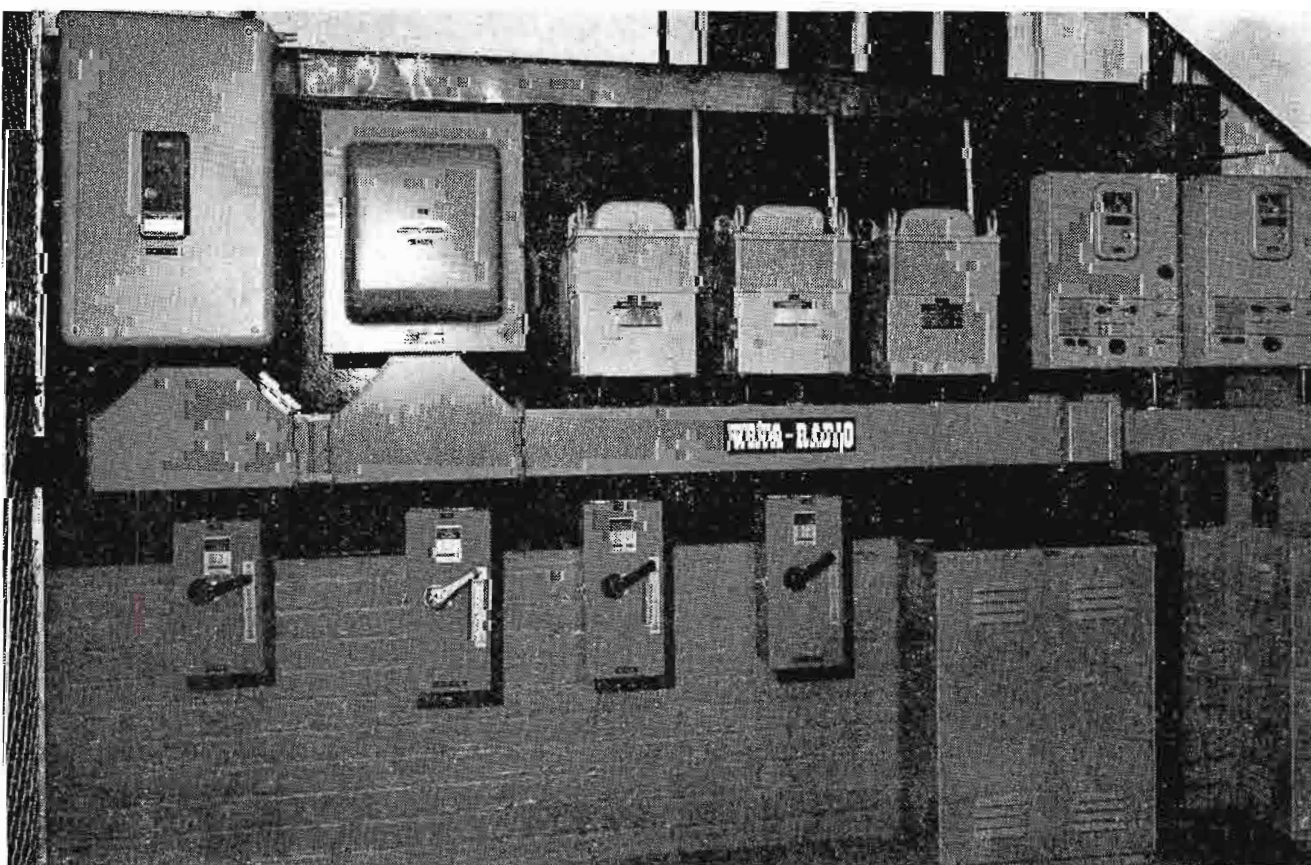

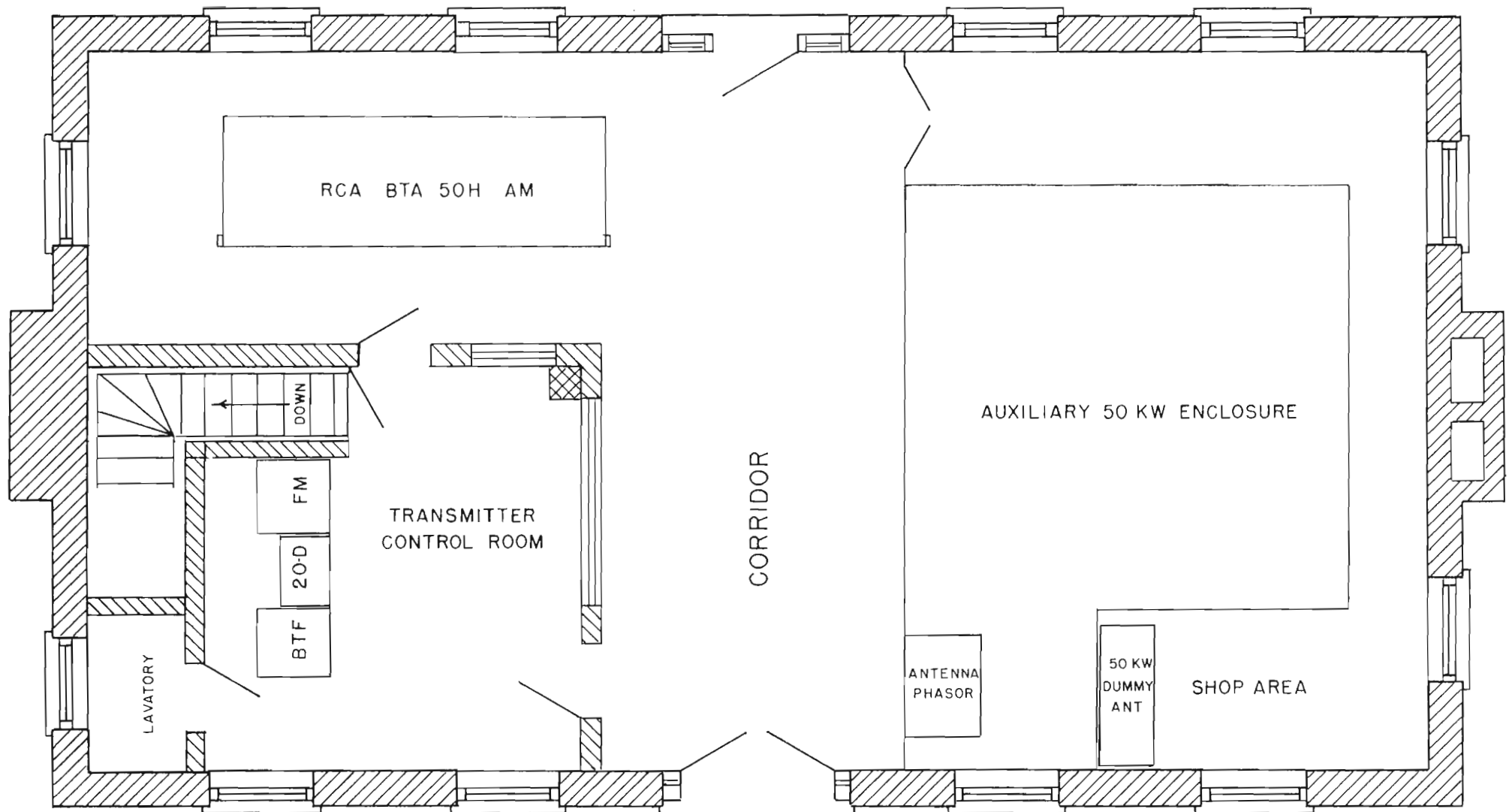
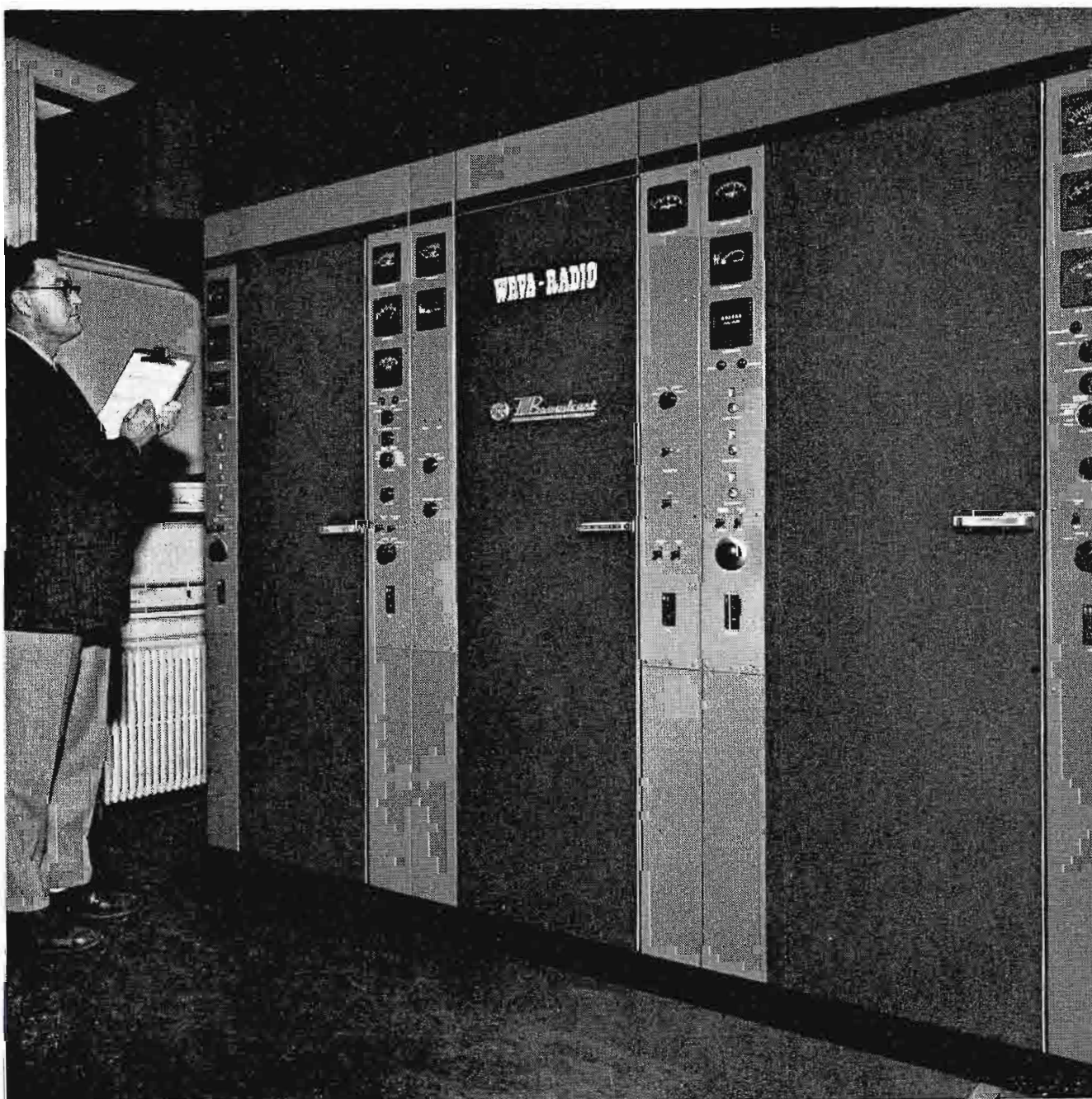

FIG. 5. WRVA-Radio transmitter building floor plan.



in excess of 100 miles out. The FM transmitter is located in the same room with the speech equipment for all three transmitters.

If, in the future, multiplex or stereo operation should be desired, the required subcarrier generators can be added to the BTF-20D very easily. No additional changes would be required in either the transmitter or antenna systems for the multiplex operation.

Formerly WRVA-Radio had a separate FM transmitter located in the transmitter building of WRVA-TV on the opposite side of Richmond. The former FM unit was operated by remote control from the station's Hotel Richmond studios. Under the present setup, one engineer can take care of all WRVA-Radio's transmitting facilities.

Antenna System

The AM antenna is directional, in order to bring into its intensive signal coverage the bulk of Virginia's population. The antenna system consists of two guyed 445-foot towers spaced 470 feet apart. The ground system is composed of 120 radials for each tower plus extended wires in given

FIG. 6. Transmitter Supervisor, Ted Chezik, at new RCA 20D FM transmitter. Above the 20D, note exhaust duct. This is equipped with booster fans as a safety factor under extremely hot weather conditions. With this arrangement, this excellent FM transmitter is a very cool running piece of equipment.

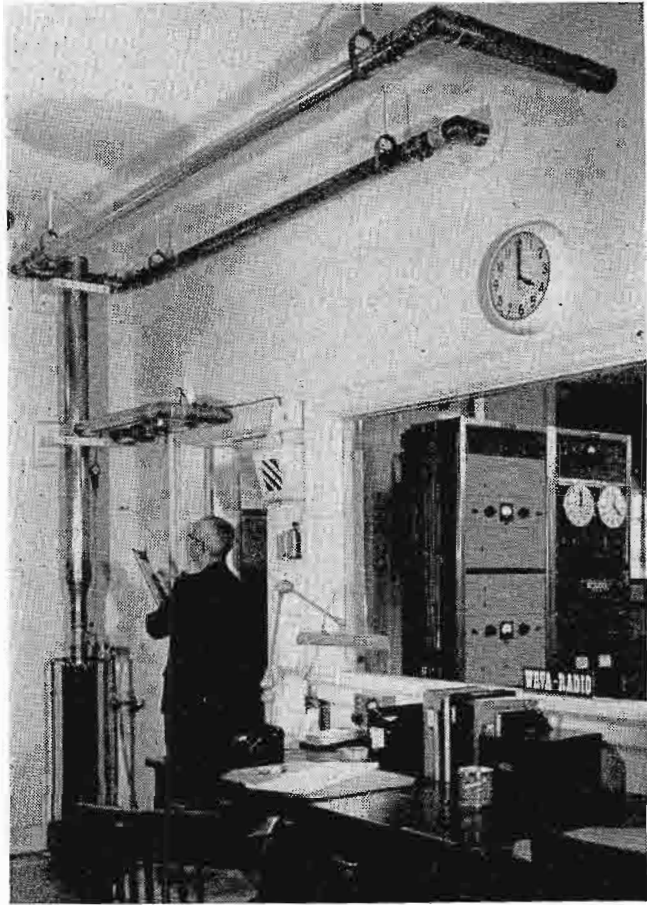

FIG. 7. A problem was solved by bringing harmonic filters of BTF-20D FM Transmitter across control room ceiling and through wall as shown. Line lengths were accurately laid out so both would be equal. The lines lead to wall-mounted diplexer where outputs of two 10-kw amplifiers are combined. Below diplexer is a water-cooled 7.5-kw load, which comes into play in event a 10-kw amplifier needs servicing. This is accomplished automatically and keeps the FM signal on the air without interruption with 50 kw ERP.

FIG. 8. The two 445-foot towers with a full-time figure eight pattern delivers a signal to the northwest which includes the metropolitan population of Richmond. The other lobe delivers its signal to the southeast which includes the heavily populated Tidewater area. The new RCA 50H transmitter has done much to improve WRVA's AM service to these large audiences.

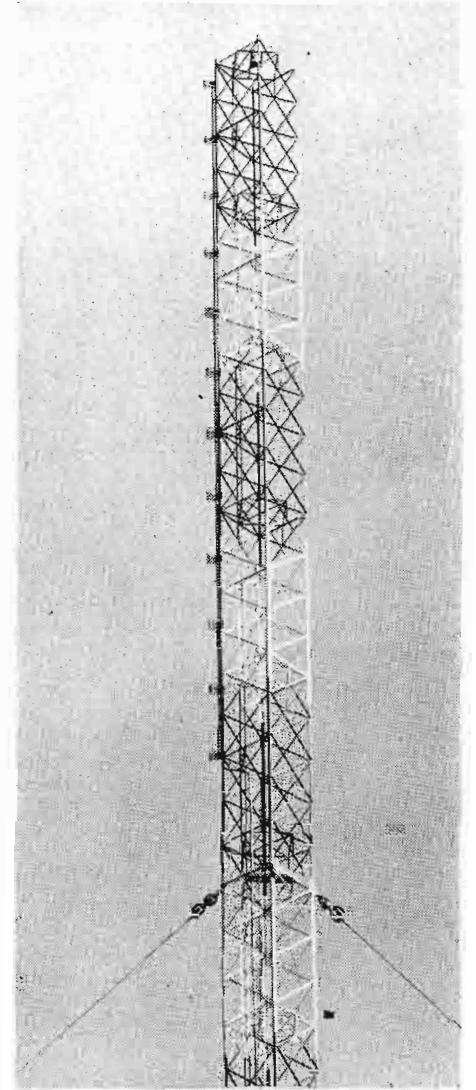
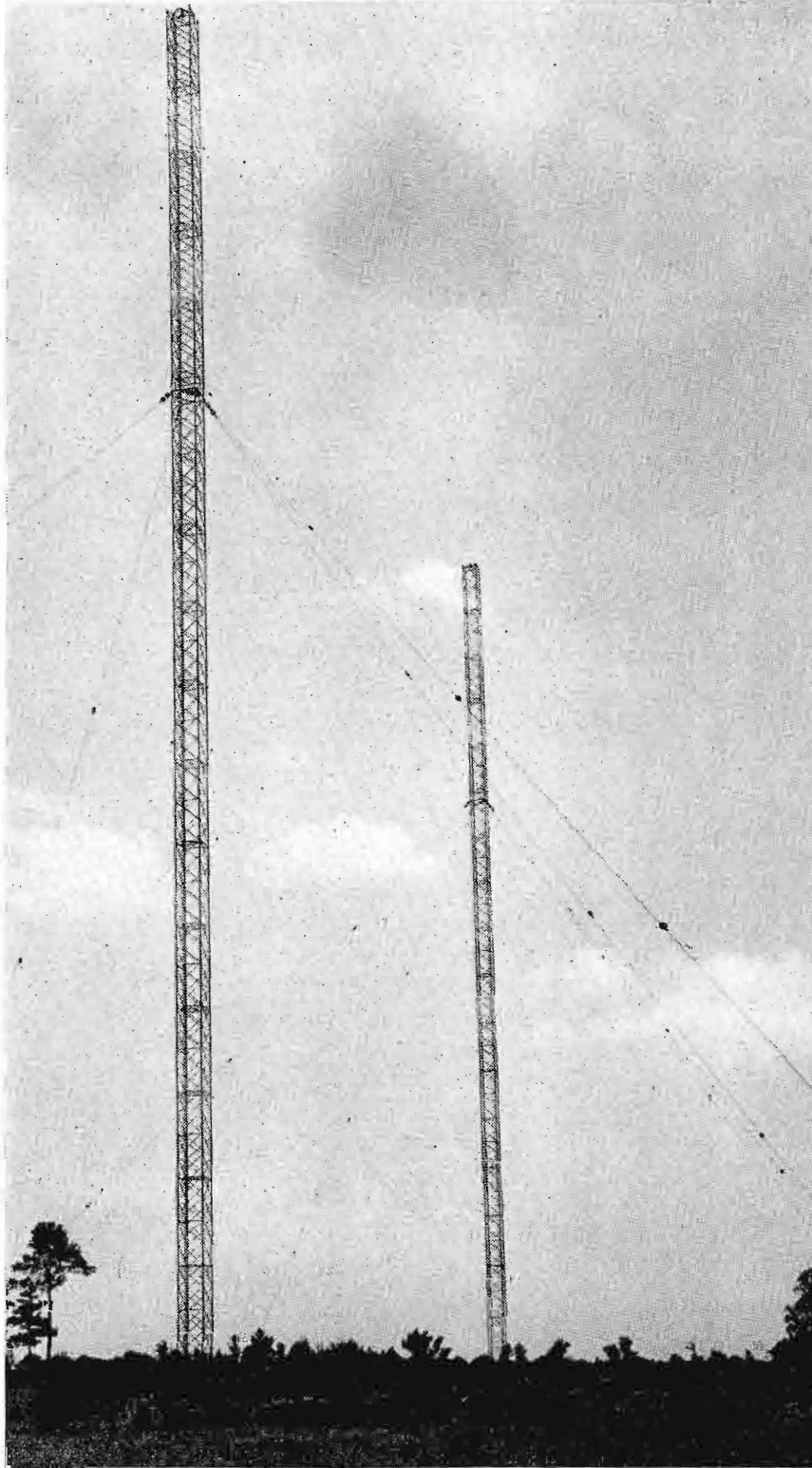

FIG. 9. The RCA BFA-12A center-fed antenna is corner mounted on one of 445-foot AM towers. At the bottom of the FM antenna the transmission line can be seen as it swings into the tower. From this point the line is supported at the cross bracing that carries the ladder, making the line readily accessible for inspection.

FIG. 10. WRVA diesel electric set rated at 250 KVA. This generator can operate new ampliphase and FM transmitters at full output plus all auxiliary building and lighting equipment. It is entirely automatic in operation.

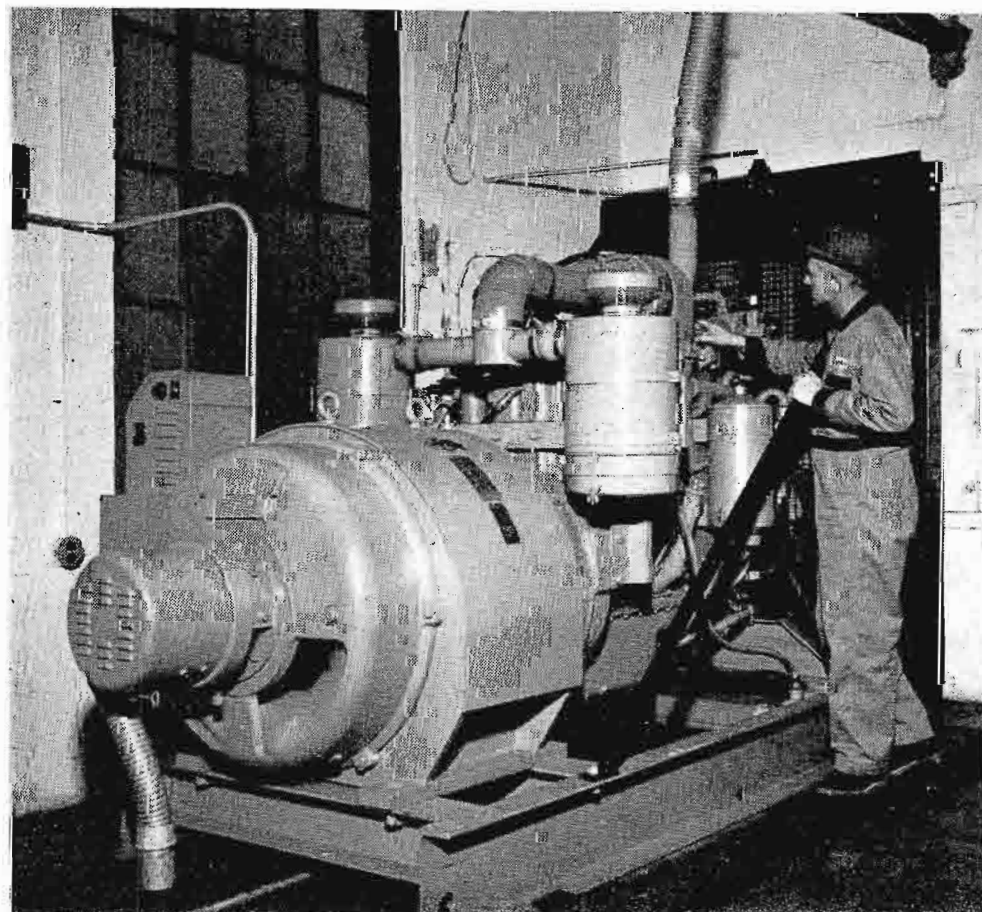
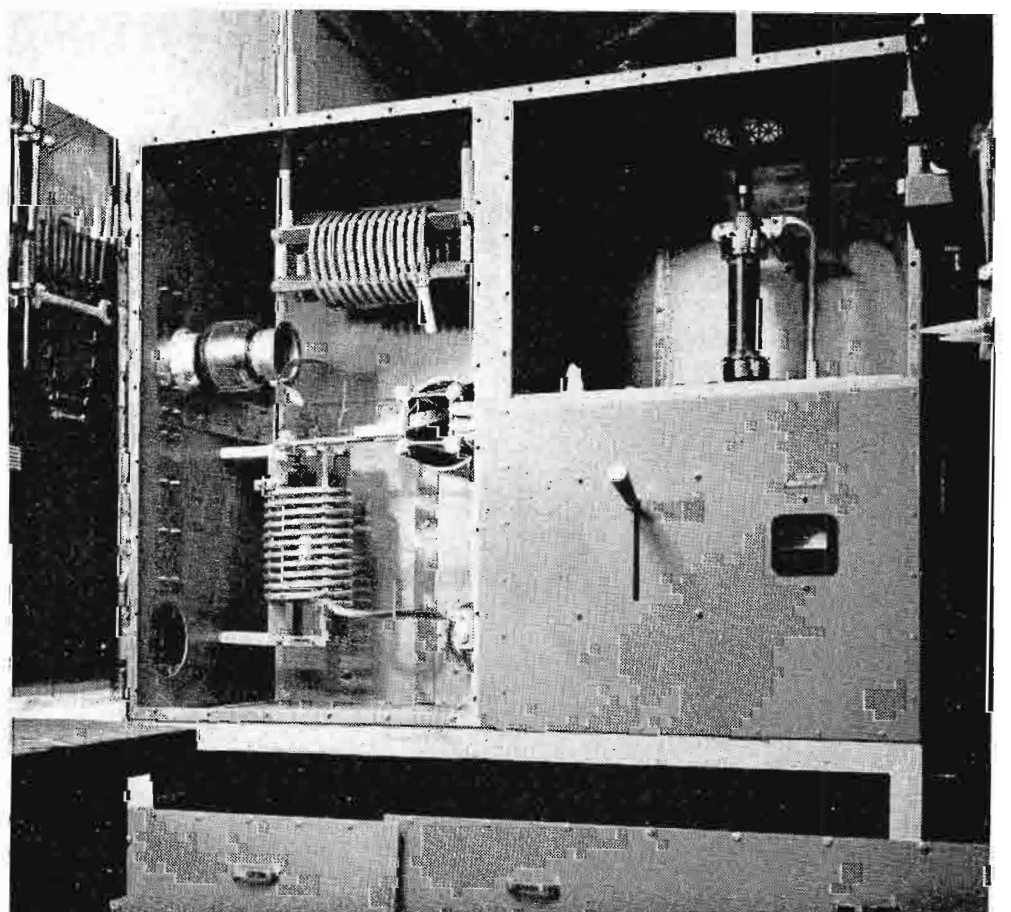

FIG. 11. WRVA 50-kw dummy antenna with covers removed, showing a special matching network on the left with the water-cooled dummy load on the right. This equipment was specifically designed by RCA for WRVA.



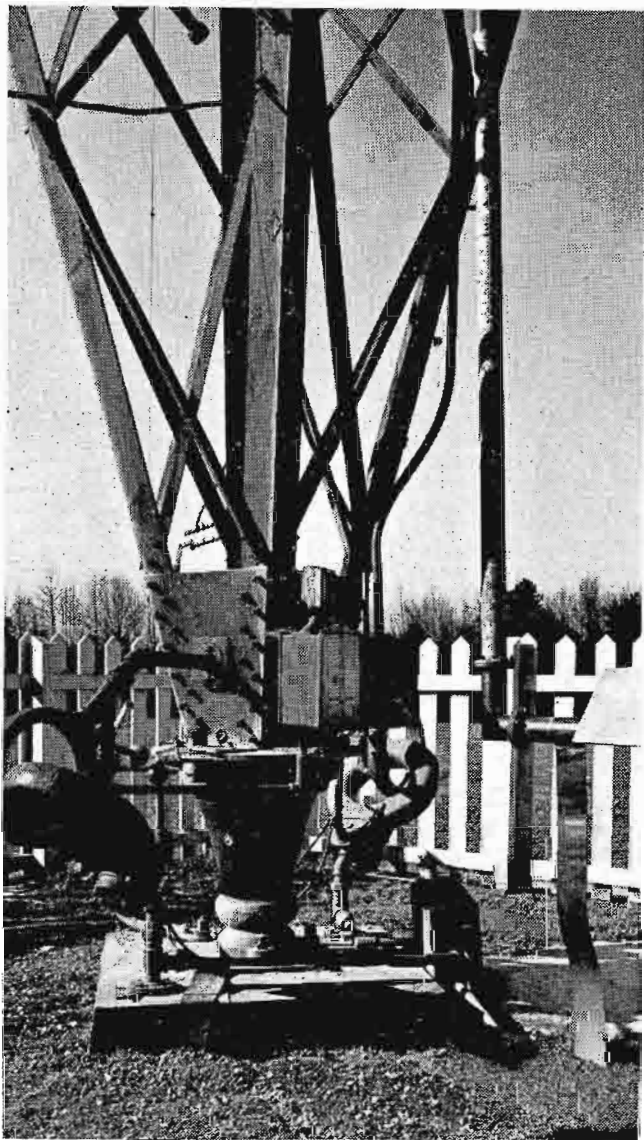

FIG. 12. The FM transmission line drops out of AM tower and tied into ground system. The bottom quarter-wave section of line is suspended by specially designed hangers insulating this section from AM tower. Tuning of stub is accomplished by adjusting movable strap connecting transmission line to tower at quarter-wave point. The horizontal portion of the line runs out a distance of forty feet then enters the ground. From this point to transmitter building line is buried well below frost line. The AM lines are also buried in this manner. The shield over the line protects it from falling ice. Two Austin transformers are shown. One supplies current for heating elements of BFA 12-section antenna. Heaters turn on automatically at low heat when temperature at ground level reaches a low of 40F.

directions to neutralize certain adverse ground attenuation conditions. Approximately 225,000 feet of wire is buried in the 100-acre transmitter site.

The Type BFA 12-bay FM antenna is side mounted on one of the AM towers. Isolation of the FM and AM signals is ac-



FIG. 13. WRVA mobile radio unit is a familiar sight in and around Richmond, Va.

complished by the use of a stub tuned to the AM frequency. This stub is formed by the AM tower and the $3\frac{1}{8}$ inch FM transmission line, tuning of the stub being done by a movable jumper between the FM transmission line and the AM tower approximately a quarter-wave up the tower. This method of AM and FM isolation has proven to be simple and effective, requiring no isolation coils or tuning capacitors. Both transmission lines to the transmitter building are buried well below the frost line.

The AM tuning houses contain matching networks for normal operation, single-tower operation, or Conelrad operation in order to cover emergency situations. A common phasing unit feeds either 50 kilowatt transmitter to the antenna system. A water-cooled dummy antenna permits testing the 50-kw transmitter not on the air. Any combination of antenna and dummy load requirement is available by push button switching. The normal transfer time from one AM transmitter to the other requires only three seconds. This switching system was designed and installed by the station's engineering staff.

FM Operating Plus

Since the BTF-20D is designed with 10-kw output amplifiers, loss of air time is diminished. Should trouble occur in either of the amplifiers the other remains on the air automatically. This is accomplished by the use of a 7.5 kw dummy load at the base of the diplexer where the output of the two amplifiers is combined. Should one of the amplifiers fail, the dummy automatically comes into play presenting the proper load for the remaining amplifier. All this occurs with no perceptible break in the program other than a power reduction which, due to the limiter action in the receiver, is hardly noticeable.

Custom Installation

The advances made in transmitter design by RCA has made it possible to do 95 per cent of the installation during normal working hours. The entire technical installation was accomplished by the station's engineering staff. WRVA engineers have, in addition, installed nearly every conceivable emergency arrangement to insure uninterrupted 24-hour service for all listeners.



STATION STAFF

(left to right)

WILLIAM R. PRESTON
Vice-President, Radio and TV
Larus & Brother Co., Inc.

JOHN B. TANSEY
General Manager
WRVA-Radio

RUDOLPH W. RAABE
Chief Engineer
WRVA-Radio

TELEVISION TOWER IN GEORGIA IS WORLD'S TALLEST STRUCTURE

WRBL-TV and WTVM With RCA Antennas
Atop 1749-Foot Tower
Cover 25,000 Square Mile Area

Piercing the sky 1749 feet above the Georgia pinewoods, a needle-like TV tower—now the tallest man-made structure in the world—is beaming television programs of WTVM and WRBL-TV, Columbus, Georgia, to an area of more than 25,434 square miles.

WTVM operates on Channel 9 and is owned by Martin Theaters of Georgia, Inc. of which Mr. C. L. Patrick is Executive Vice President. Channel 3 WRBL-TV is owned by Columbus Broadcasting Com-

pany. J. W. Woodruff is president and general manager.

Coverage Area Multiplied

To pinpoint the Georgia-Alabama border with the world's tallest landmark was not the only vision of the management of the two stations which began operation in 1960 sharing a 1260-foot TV tower. Extending the structure last summer to almost a third of a mile high widened the transmission range for telecasts to reach many viewers in distant areas for the first time. Clear pictures are now being reported as far south as the Gulf of Mexico, and west to Montgomery, Alabama. Reception in Atlanta and Macon, Georgia, has greatly improved.

RCA Prime Contractor

Design, fabrication and erection of the 215-ton structure was subcontracted by RCA to *Stainless, Inc.*, North Wales, Pa. *Bethlehem Steel Company* supplied most of the tower steel as well as the six miles of guy-strand cables which hold the tower in position. Erection was initially performed by *J. M. Hamilton, Inc.*, Gastonia, N. C. and the tower extension was performed by *Furr and Edwards*, Rome, Georgia.

Original Tower Extendable

Prior to construction of the new tower the TV antennas of WTVM and WRBL-TV were supported by a 1000-foot, triangular tower ten feet wide on each face. This special tower exceeded the structural specifications of ordinary TV towers of this height; it was designed to allow additional sections that would ultimately support the antennas at a height of 1760 feet above ground at wind velocities up to 110 mph. (50-pound wind loading).

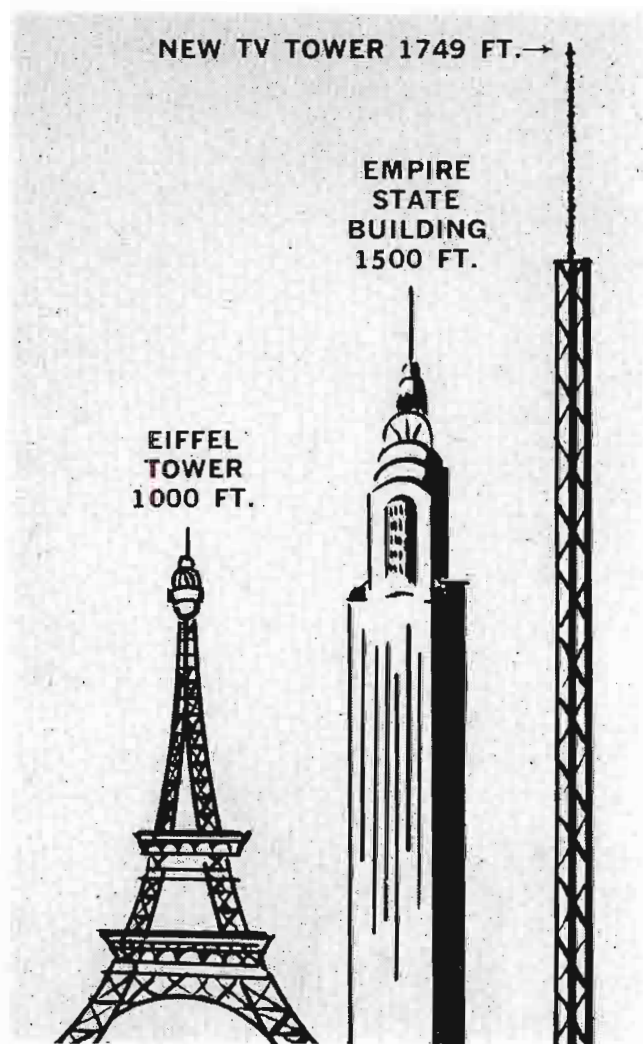

FIG. 1. Comparison of world's tallest tower to other famous structures.

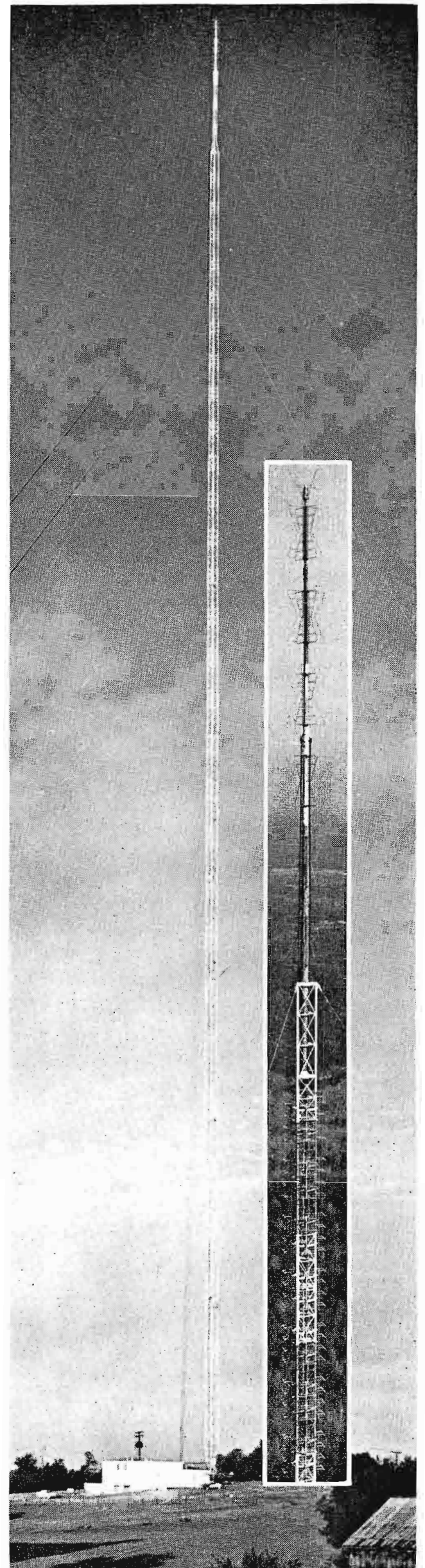

FIG. 2. Full-length view of the WRBL-TV/WTVM tower with inset showing two antennas at top.

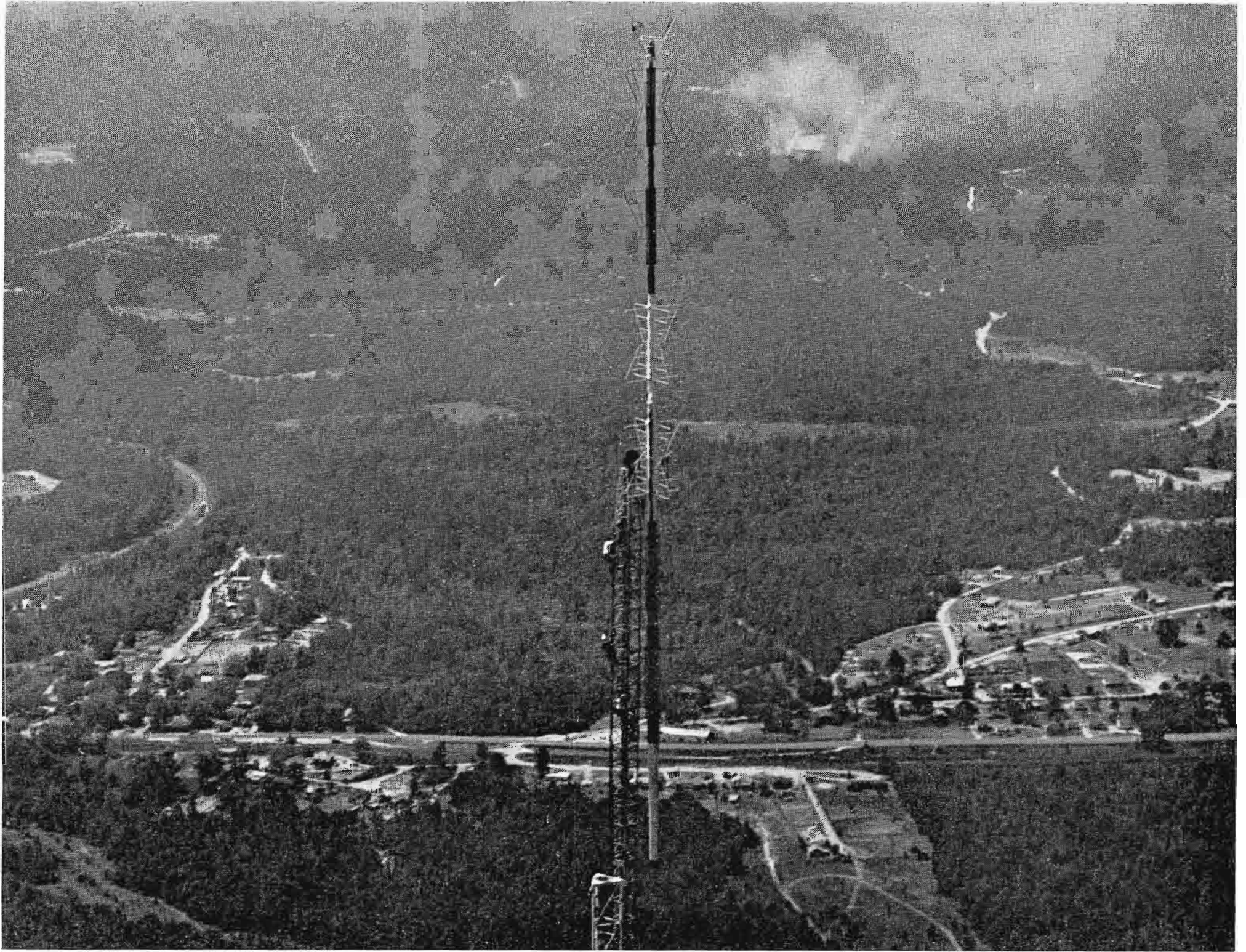

FIG. 3. Aerial view of the world's tallest structure as the RCA Super-Turnstile Antenna was moved into place. Men on gin-pole indicate comparative size of antenna.

Use of an "extendable" tower such as this was the key to substantial savings in time and expense for the two stations. It eliminated the work of dismantling an otherwise inadequate tower, and replacing it with one of suitable design.

Tubular materials are used throughout the entire structure.

High Gain TV Antennas

At the summit of the structure is a stacked TV antenna and lighting beacon assembly 260 feet in length and weighing ten tons.

The antennas consist of an RCA Type TF-6AL Channel 3, 6-section Super-Turnstile and an RCA Mark II Super Gain Channel 9, 18-layer antenna. Members supporting the antennas had to be designed and fabricated to rigid electrical and mechanical specifications.

Tower Extended Without Lost Air Time

Extension of the 1260-foot tower to the new height of 1749 feet was completed in less than two months, ahead of schedule, and without loss of air time for either station. Television transmission continued during construction through two temporary antennas mounted from one side of the original 1000-foot tower. After erection of tower steel was completed, and the permanent antennas relocated at the top of the new tower, the temporary antennas were removed.

Safety First

During construction the erection crew ascended and descended the tower in a temporary elevator car operated by cables attached to the gin pole. For safety and efficiency, constant voice communication was maintained between the men on the tower and those manning the lifting hoist and tag lines on the ground.

FIG. 4. Looking up the tower between two of the four stacks of super-gain antennas.

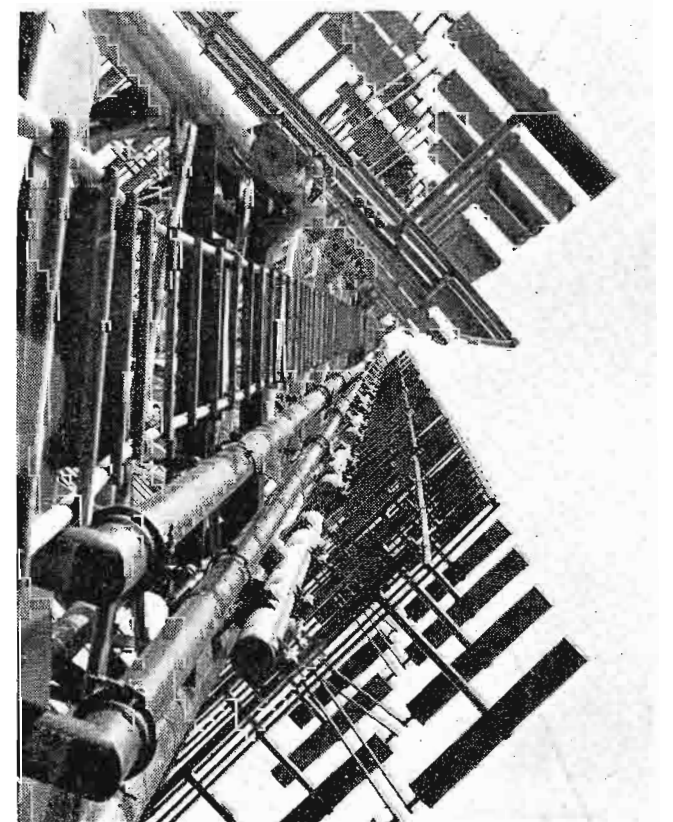

Outrigging of Temporary Antennas

WRBL-TV's temporary antenna was a Channel 3, RCA single-section Super Turnstile which was mounted on the permanent structure with its center of radiation 850 feet above ground. The dual run of $3\frac{1}{8}$ -inch line leading to the original RCA six-section Super-Turnstile Antenna was disconnected at the 1,000-foot elevation and, by means of an adaptor/transformer and elbows which formed a "U" turn, was run back down the tower for a distance of 160 feet. This co-ax was then connected to the inputs of the single section antenna at the 841-foot level.

The second temporary antenna, a Channel 9 Super-Turnstile, was installed on the tower face with its center of radiation 804 feet above ground. The $6\frac{1}{8}$ -inch transmission line was then disconnected from the Super Gain antenna and connected to the standby antenna by means of an adaptor/transformer, a 50/50 power-dividing tee, and a 90-degree quadrature section.

Dismantling Original Antennas

After installation and check-out of the temporary super-turnstiles on the side of the 1000-foot tower, the stations transferred to them and the two original antennas, plus a 15-foot transition section that couples the super-gain antenna to the tower, were removed and lowered to the ground to allow for tower extension.

Ground Assembly of Tower Sections

To support the antennas at the extended height, the project required the addition of 488 feet of steel to the existing 1000-foot tower. Sections of the triangular structure, 25-feet in length, were fabricated at the *Stainless Pine Forge* plant and shipped knocked down by rail and truck to the tower site. These lengths were then bolted together on the ground ready for erection.

The gin pole was an auxiliary tower section equipped with a rotating pulley at the top. Bolted to the side of the main tower, it was used together with a ground lifting hoist and load line to hoist sections to be bolted to the top of the structure. As sections were joined, the gin pole was raised 50 feet, until all 488 feet of tower were added.

Relocating High Gain Antennas

The Mark II Super-Gain antenna and the TF-6AL Super-Turnstile and light beacon assembly, which attain a total length of 261 feet, were then installed successively at the top of the tower at an elevation of 1488 feet. New sections of

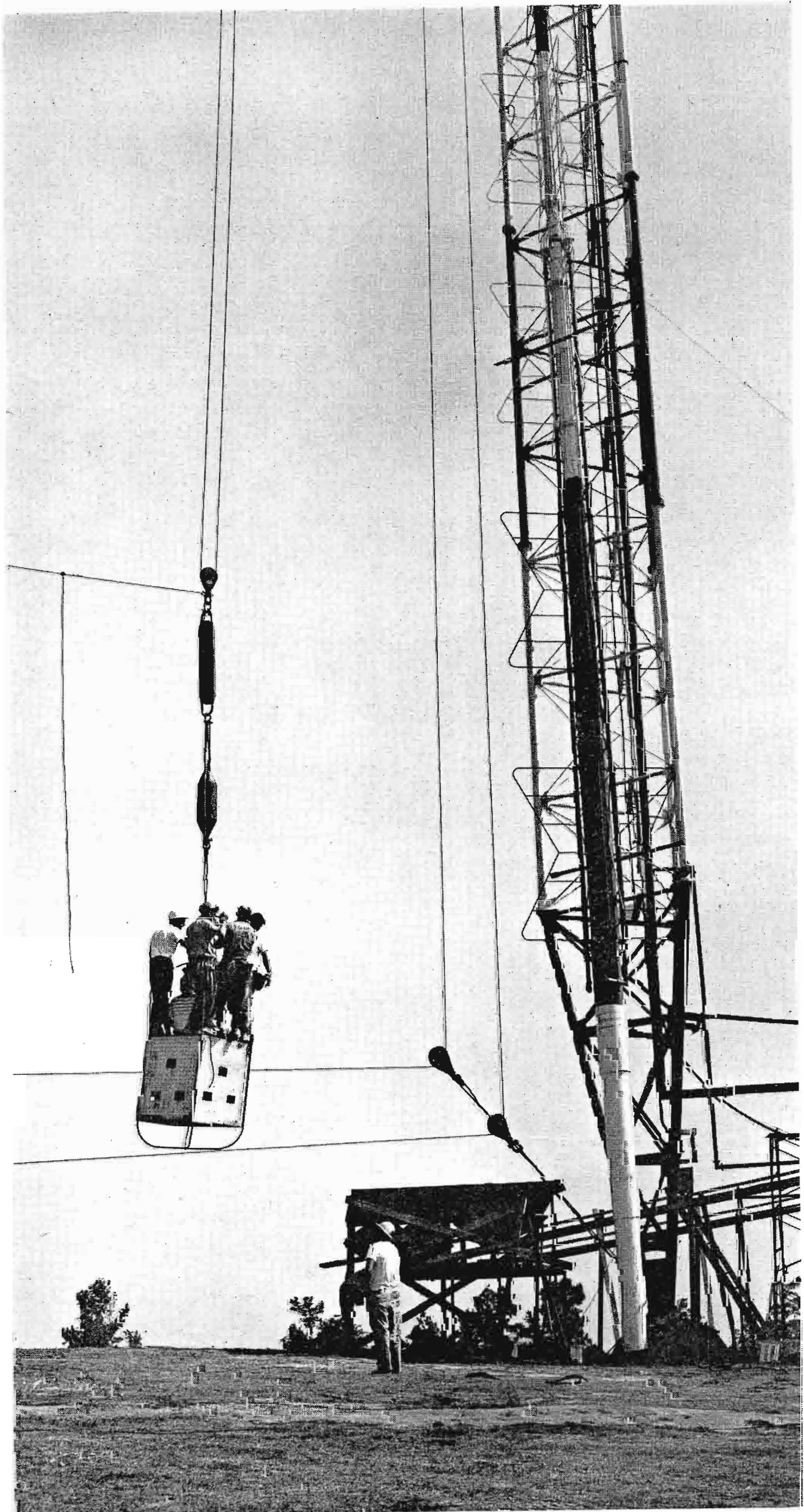

FIG. 5. Riggers used this temporary elevator car (tool basket) to ascend and descend the tower during the extension of tower height.

transmission lines were installed through the tower extension and connected to the permanent antennas. After check-out, operations were transferred to the main antennas, the temporary antennas were lowered. Following this, the new tower sections were painted to complete the final phase of construction.

Pre-Stressed, Proof-Loaded Guys

A total of 24 guy cables are installed at eight levels in three azimuth directions, utilizing two levels of existing guys with added link extensions. Use of higher strength, bridge-strand cable permitted a reduction in the diameter of the guy, contributing to reduced wind and ice load. All guys were equipped with open sockets for connection to the tower, and with closed-bridge sockets and tensioning adjustments at the ground anchorages.

Pivot-Base Design

As opposed to a fixed-type design, the base of the 1749-foot structure is "pinned" by a pivot configuration which assures even distribution of the 215-ton load, and eliminates any redundant moment at the bottom of the tower.

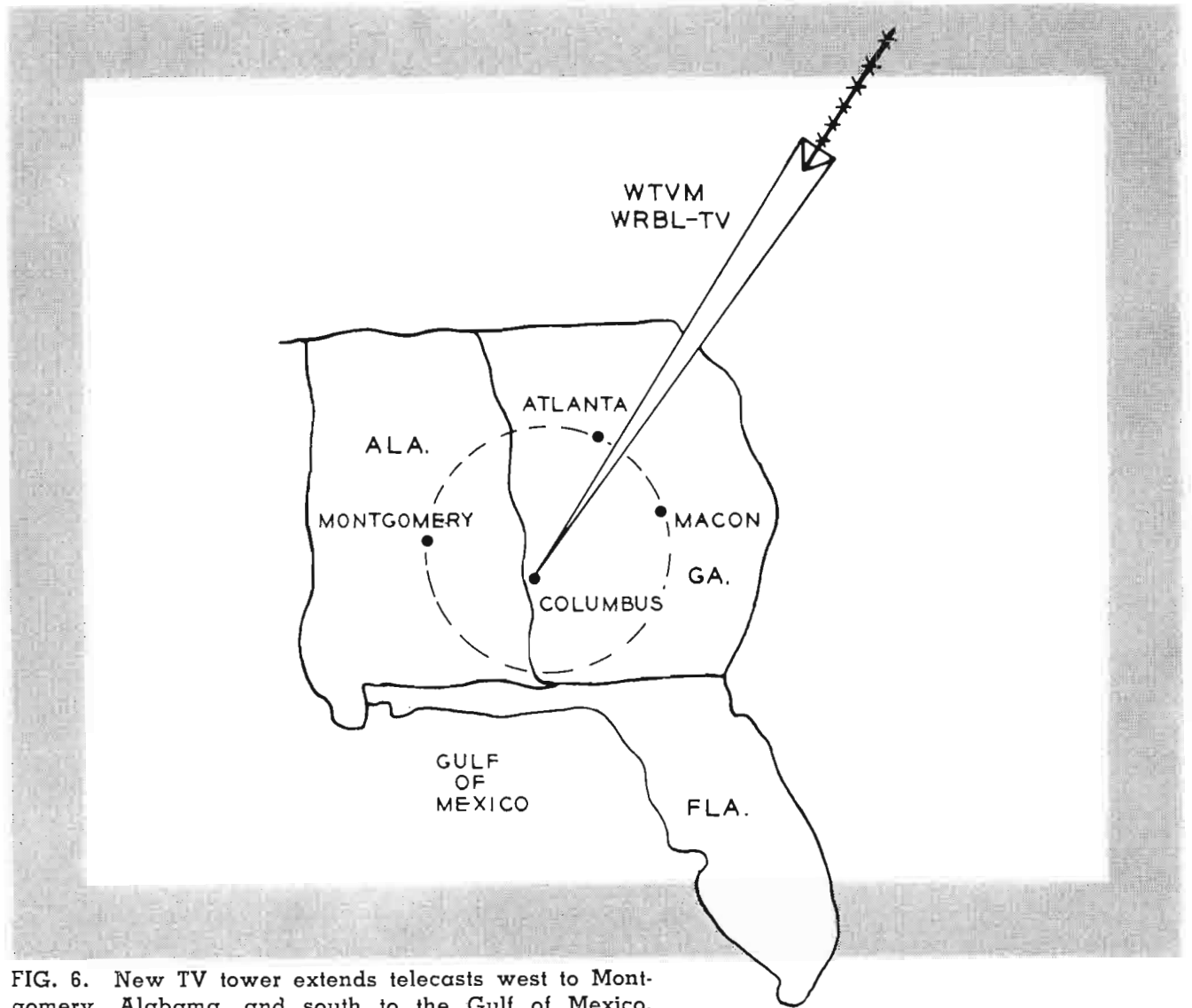

FIG. 6. New TV tower extends telecasts west to Montgomery, Alabama, and south to the Gulf of Mexico.

FIG. 7. Side view of tower and antennas showing guy attachments.

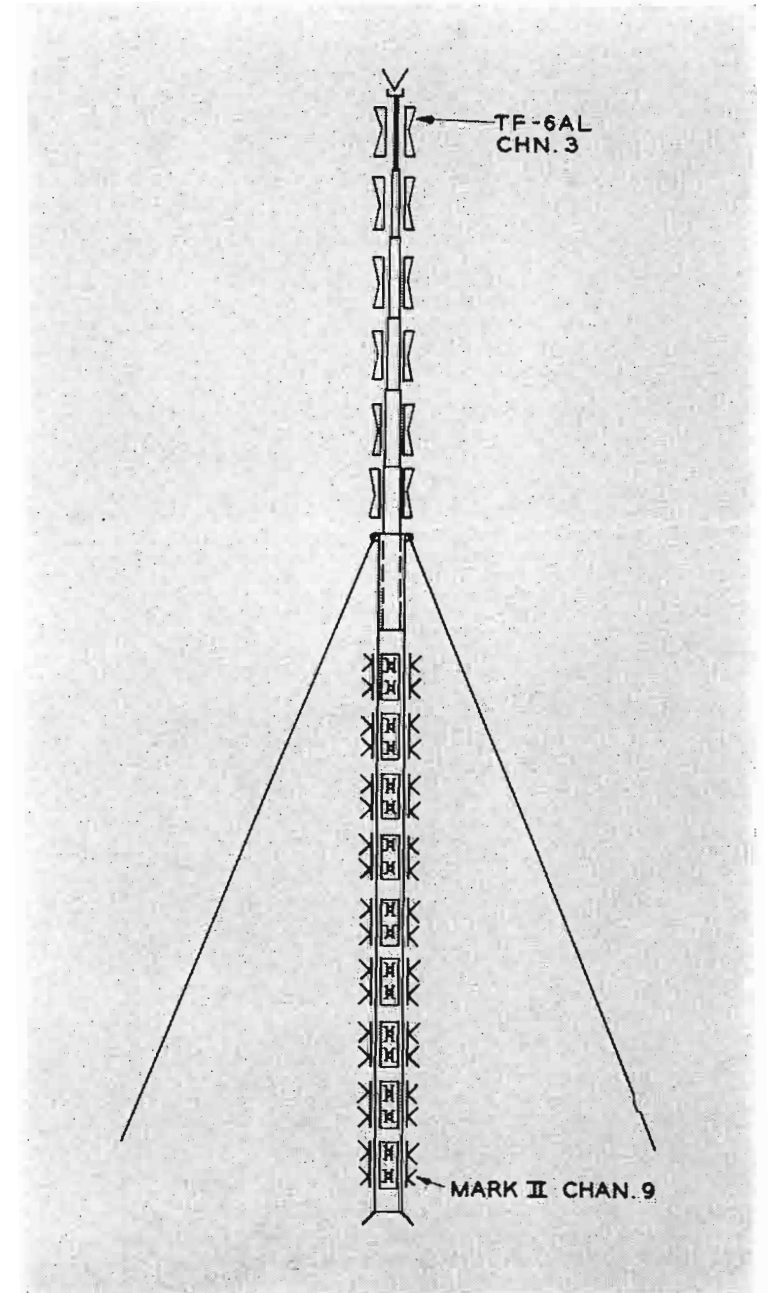
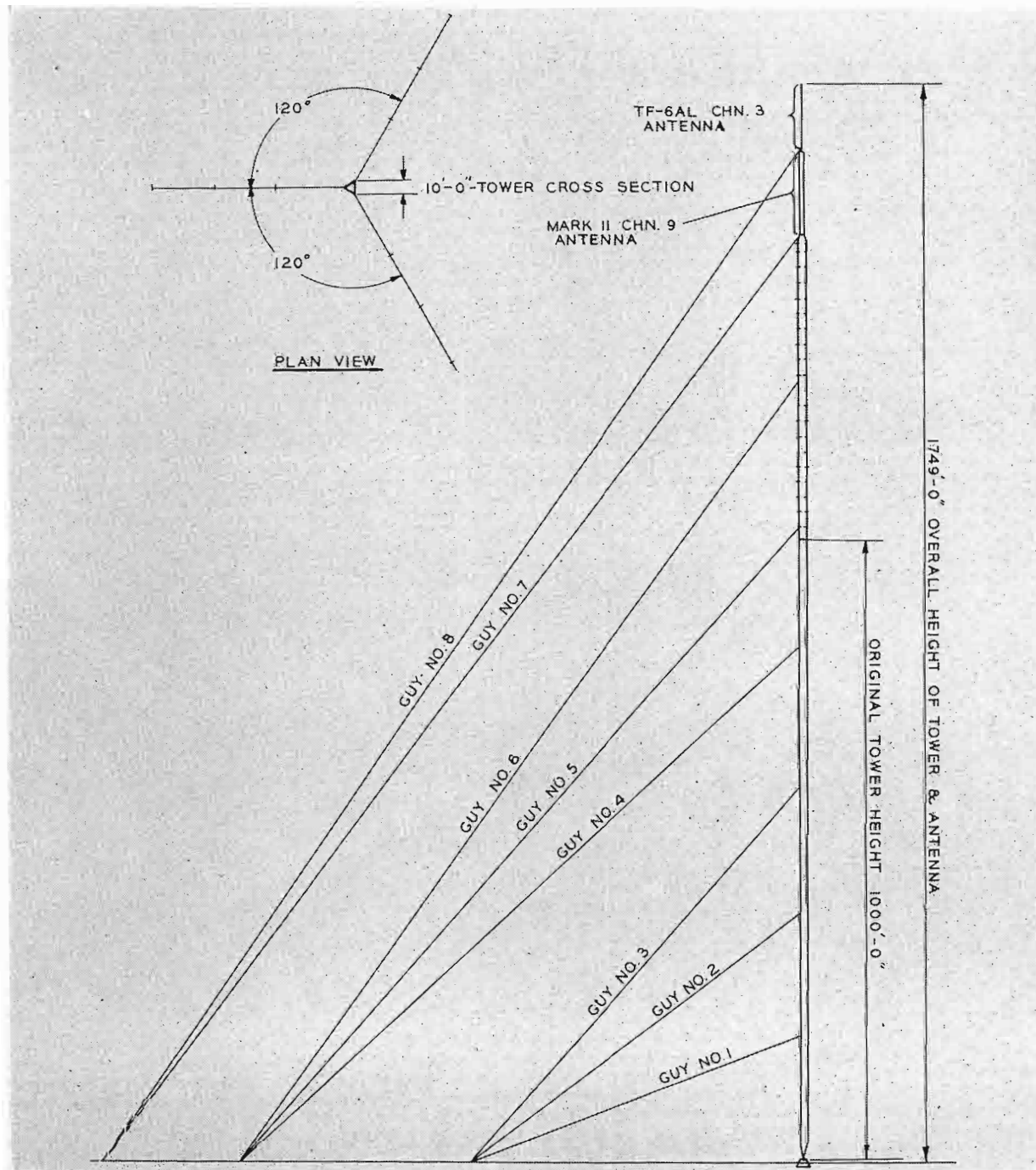

FIG. 8. Draftman's drawing of two antennas "stacked" atop the world's tallest tower.

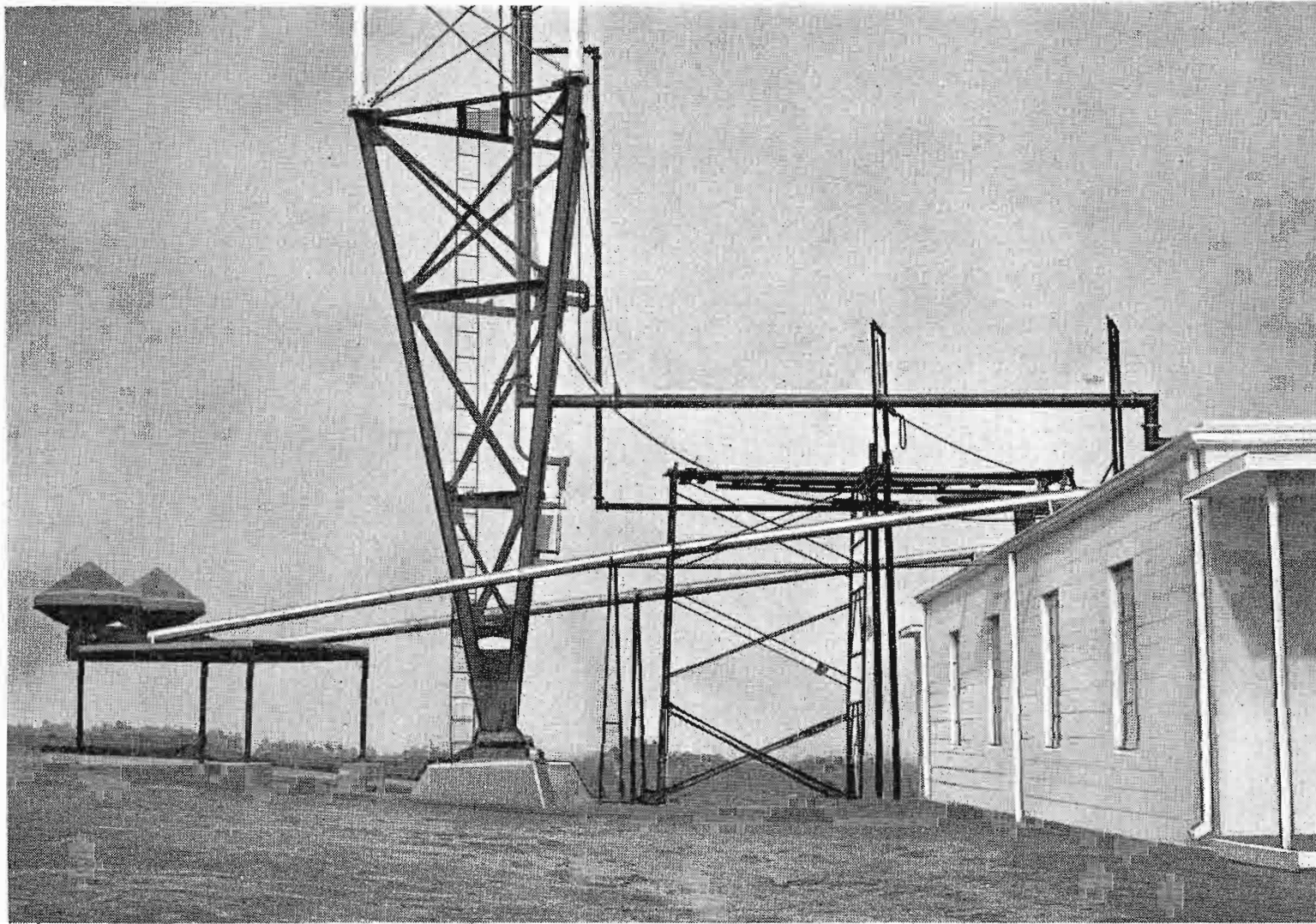

FIG. 9. Beside assuring even distribution of load, the pivot base design provides utmost simplicity and clean access lines at base of tower.

FIG. 11. Side-mounting of temporary channel-9 antenna.

"Electronically" Designed Tower

The WTVM/WRBL-TV structure is the 27th tall tower (over 1000 feet) to be designed with the aid of a new electronic computer installed at the subcontractor's headquarters in North Wales, Pa.

Utilizing data such as moments, shears, reactions, axial stress and deflections at various guy levels, calculated and programmed by the subcontractor's engineering staff, the computer expedites the final tower design and with much greater speed and accuracy than heretofore possible.

FIG. 10. Tower leg flanges are precision welded for snug fit and ease of erection.

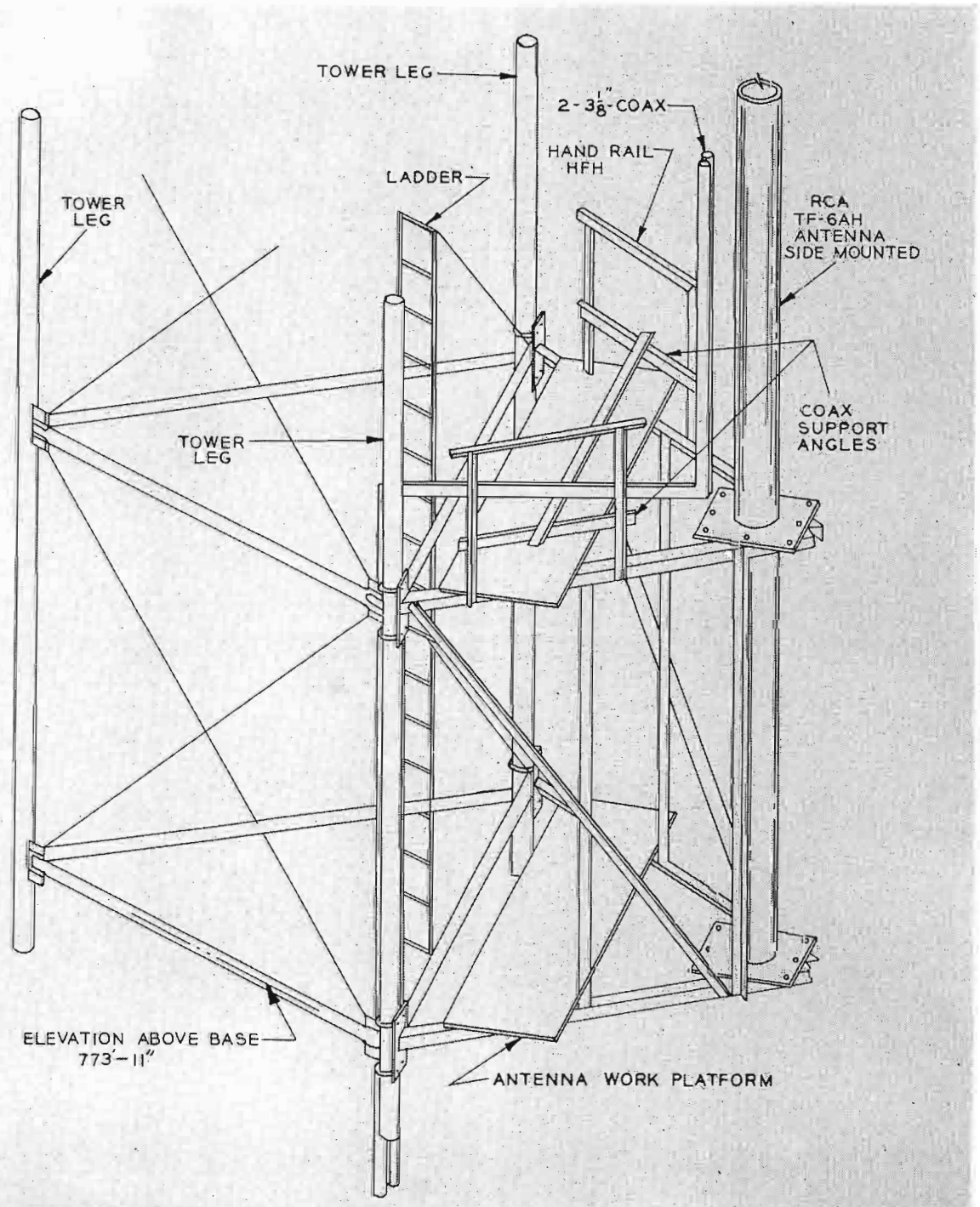
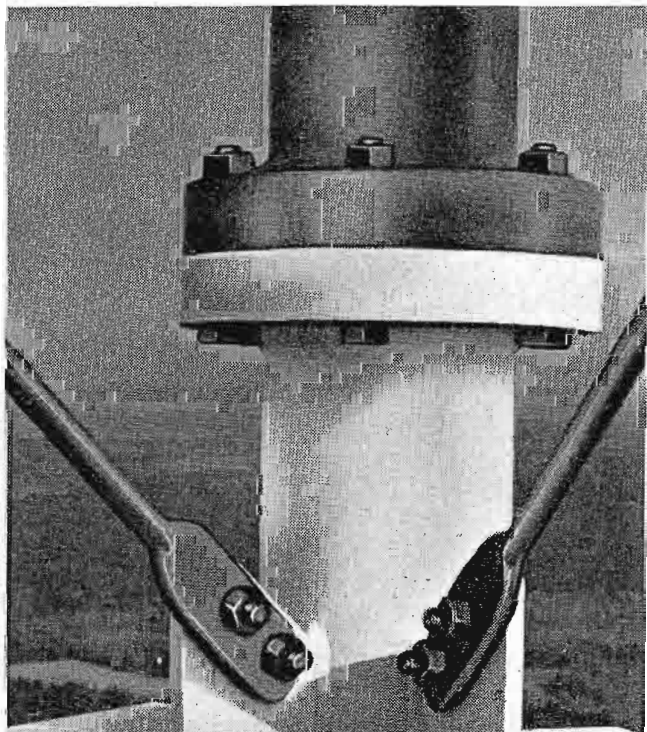

WRBL-TV OPERATING CHANNEL 3 FROM WORLD'S HIGHEST STRUCTURE

... Increases Coverage From 37 to 66 Counties

Rising above the pinelands southeast of Columbus (Ga.) is a steel, copper, glass and plastic structure that is the tallest of the monuments to man's ingenuity . . . a slender, needle-like edifice that elevates two television-transmitting antennas almost a third of a mile into the sky.

The beacon atop the Channel 3 super-turnstile antenna of WRBL-TV . . . the "WeeReBeL" station . . . is 1749 feet above ground.

WRBL-TV Management, History and Other Data

Columbus Broadcasting Company, the operator of WRBL-TV, WRBL-AM and -FM, is a private corporation owned by four interests: J. W. Woodruff, Sr., J. W. Woodruff, Jr., J. Barnett Woodruff and the R. W. Page Corporation. *Columbus Broadcasting* is the offspring of a merger between the Woodruff-owned WRBL-AM and -FM radio operations and the owners of the *Columbus Ledger-Enquirer* newspaper-publishing organization.

WRBL-TV started operations in 1953, with a seven-hour daily schedule, using a studio and office building constructed for the WRBL-AM and -FM operations during 1950. The building was enlarged and modified to accommodate the TV operation. A CBS-TV affiliate since the first day of operation, network programming was delivered to Columbus via an air pickup of the CBS affiliate in Atlanta at a site on Pine Mountain, a peak 32 miles north of Columbus. Microwave formed the link between WRBL and Pine mountain.

The trademark of WRBL-TV is a caricature of a small boy, nattily attired in a Confederate uniform, with the name "WeeReBeL". The George P. Hollingbery Company serves as national sales rep.

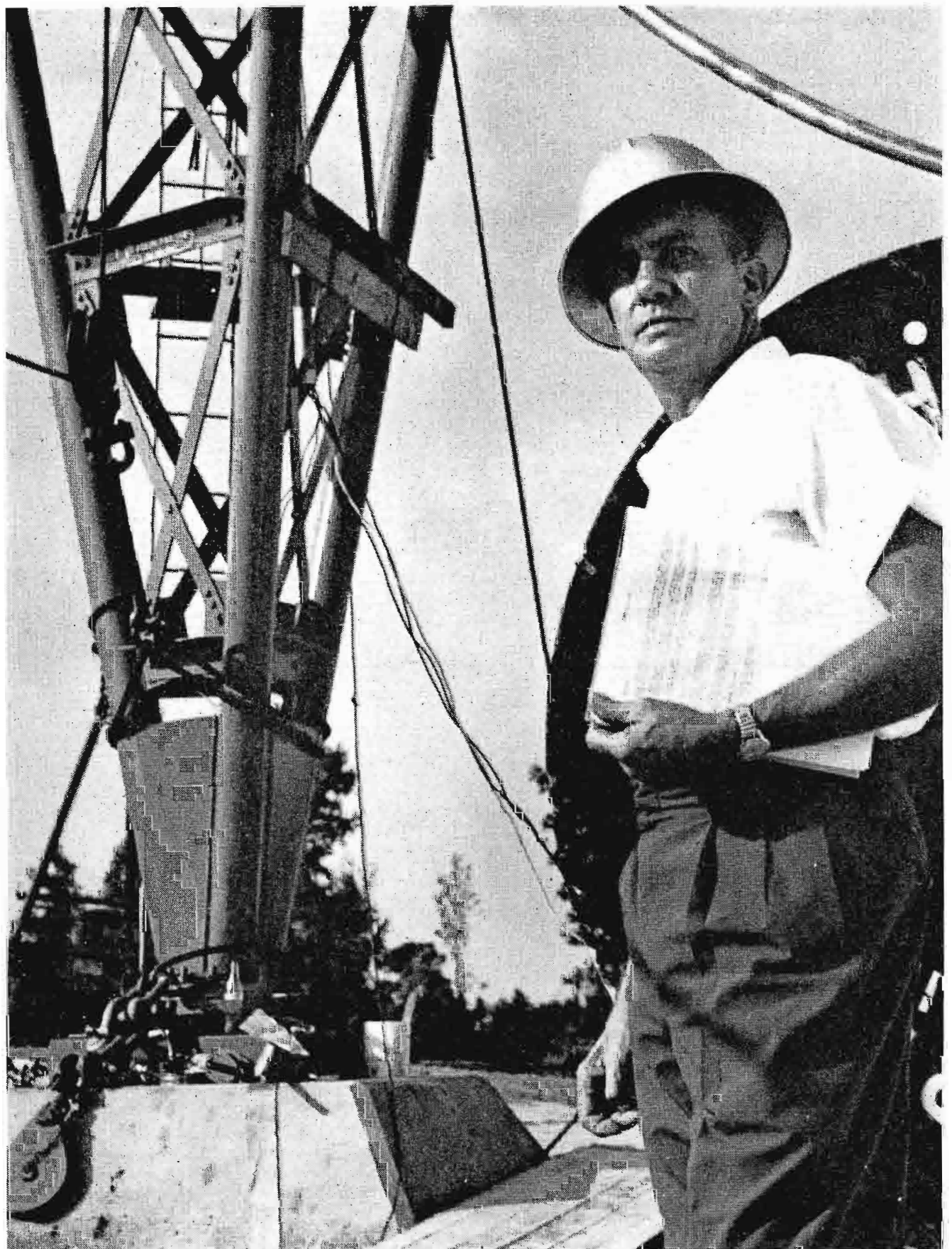

FIG. 1. Joe Gamble, WRBL-TV's chief engineer, shown at the tower during construction.



FIG. 2. The WRBL trademark . . . a clever device that communicates the stations' call letters as well as its geographic location.

WRBL-TV originally went on the air as a Channel 4 station in 1953 with transmitter and antenna in downtown Columbus. During 1955, WRBL-TV went to full power and moved its transmitter site across the Chattahoochee River to Phenix

City (Alabama). The de-intermixture proceedings of 1957 reassigned WRBL-TV to Channel 3 and the present site went on the air during 1960 using a 1000-foot tower to place the top of the antenna 1260 feet above ground. WRBL-TV shared this tower with WTVM, also of Columbus.

At the time of erection of the 1000-foot tower, the managements of both stations anticipated an increase in tower height. For this reason, the tower was designed to be "ex-tendable" so that additional height could be added later without obsolescence of the existing tower. (See "Television Tower In Georgia Is World's Tallest Structure," page 55.)

WRBL-TV Programming

As mentioned earlier, WRBL-TV serves as the primary CBS-TV outlet in Columbus, however, WRBL-TV broadcasts much local programming.

"At Home With Rozell", a morning program of primary interest to the housewife, had its first airing in September, 1954 and is still on the daily schedule.

Mrs. Rozell Fabiani, hostess of the program, has won many public-service awards for her commercial contributions to the television art. These awards include *McCall's Gold Mike Award* (two consecutive years), the highest award given women in the radio and television field. Mrs. Fabiani also holds an honorary Life

Membership in the *National Congress of Parents and Teachers*. In 1960, "At Home With Rozell" won the second highest honor in the *Carol Lane Awards for Traffic Safety Programs* as a result of "Operation Courtesy," a feature beamed to promote traffic safety among high-school students. The latest laurel bestowed on the program is the top award in the television class of the 1962 *Grocery Manufacturers of America Convention*.

"Chattahoochee RFD", a program for the agricultural interests in the area won the *Georgia Farm Bureau Award* as the best program in the agricultural category.

"Colonel Chick and Bozo," obviously a children's program, has a daily guest list of local children. The program has been a personality children's hour on WRBL-TV since the first programming days of the station back in 1953.

News and Public Affairs holds a respected place in the programming concept of WRBL-TV. Under the able direction of George Gingell, a news-corps of eight people gather, prepare and present news programming four times daily. The feature-news program in this schedule is "Evening Edition" on the air for a full hour daily. Dick McMichael serves as anchor man for the program. A film sequence, entitled "Pulsebeat", presents human-interest features of local origin. It was conceived by Jack Gibney.



FIG. 3. WRBL-AM-FM-TV Office and Studio Building at 1350 Thirteenth Avenue in Columbus. Constructed in 1950 for WRBL-AM and FM, the facility was enlarged during 1953 to accommodate the TV operation. The tower in the background supports the microwave antenna for the STL (studio-to-transmitter) link.





FIG. 4. The "Colonel Chick and Bozo" set. The program puts local youngsters on camera during its daily late-afternoon time slot. "Colonel Chick" is Charles "Chick" Autry and "Bozo" is Jack Morin. Pictured with them are local children.



FIG. 5. Mr. J. W. Woodruff, Jr., President and General Manager of WRBL-AM-FM-TV. He has served in this capacity since 1935 (WRBL-AM went on the air in May, 1928).

affairs programming is under the talented control of George Gingell.

Joe Gamble has served as chief engineer since 1944. He and his staff supervised and coordinated all installations of RCA equipment in the company's AM-FM-TV operations.

In the sales department, George Jenkins directs national sales while Robert Walton serves as Local Sales Manager.

FIG. 6. The set for "Evening Edition," a 45-minute program that precedes Walter Cronkite's world-and-national news program. From left to right: George Gingell, Dick McMichael, Doug Wallace and Walter Graham.

Another segment of "Evening Edition" is "Personal Opinion", the station's daily editorial. The voice of *Opinion* is that of George Gingell. The sports report is handled by Walter Graham preceding the weather report with Doug Wallace. Mr. Wallace too, is an old hand at WRBL-TV, for he's been giving the weather facts and figures since those early days in late November, 1953.

As a wrap-up for "Evening Edition", WRBL-TV joins the CBS-TV network for Walter Cronkite's early-evening world-and-national news report from New York.

"Evening Edition" is augmented by a 30-minute news program at 7:30 AM and another at 11:00 PM. The mid-day news occupies a 15-minute slot at 1:00 PM and is edited to a great extent for the predominantly-female audience.

WRBL-TV People

Mr. J. W. Woodruff, Jr. has served the company since 1935 as General Manager (WRBL-AM went on the air during July, 1928 and WRBL-FM during September, 1946).

Ridley Bell serves as station manager and director of operations; news and public

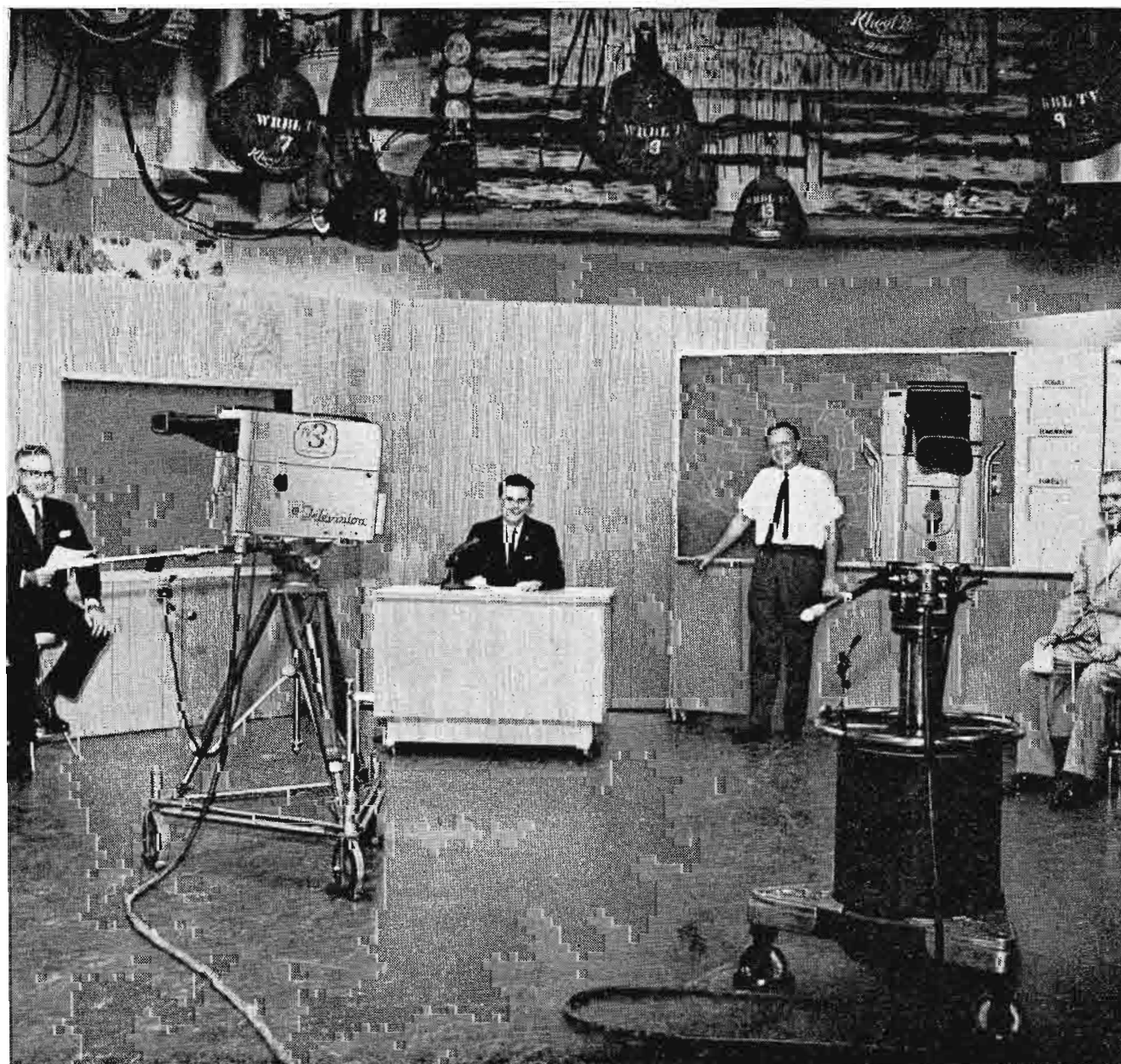



FIG. 7. WRBL-TV Station Manager, Ridley Bell.

Indicating the high calibre of *Columbus Broadcasting Company* management, fifteen employees have a service record of ten years or more while an additional 23 have established service in excess of five years.

Transmitter Equipment

WRBL's transmitter facilities are 100 percent RCA-equipped . . . AM, FM and TV. The AM transmitter is a 5-kilowatt BTA-5H operating on 1420 kc; the FM facility is a BTF-3B transmitter coupled to a BFA-8 antenna. The combination delivers 21 kw effective radiated power.

The TV transmitter is a 25-kilowatt TT-25CL transmitter while the antenna is a six-section TF-6AL Super Turnstile. This combination results in maximum power . . . 100 kw ERP. WRBL-TV uses a TTC-5 Control Console with the transmitter.

Studio Equipment

Three TK-31 Image Orthicon Cameras serve WRBL-TV's "live" studio in the pickup of the local programming mentioned earlier.

New Antenna Height Increases Coverage to 66 Counties

The additional 488 feet of tower height lets the 100-kw signal of WRBL reach out to a 66-county area (estimated) that includes Macon on the east, Albany on the southeast, Dothan on the south and Montgomery on the west, not to mention the hundreds of smaller communities in the Alabama-Georgia countryside.

The Columbus TV market area has practically doubled since the increase in tower height. Earlier, the market comprised only 37 counties as compared to the present estimate of 66.

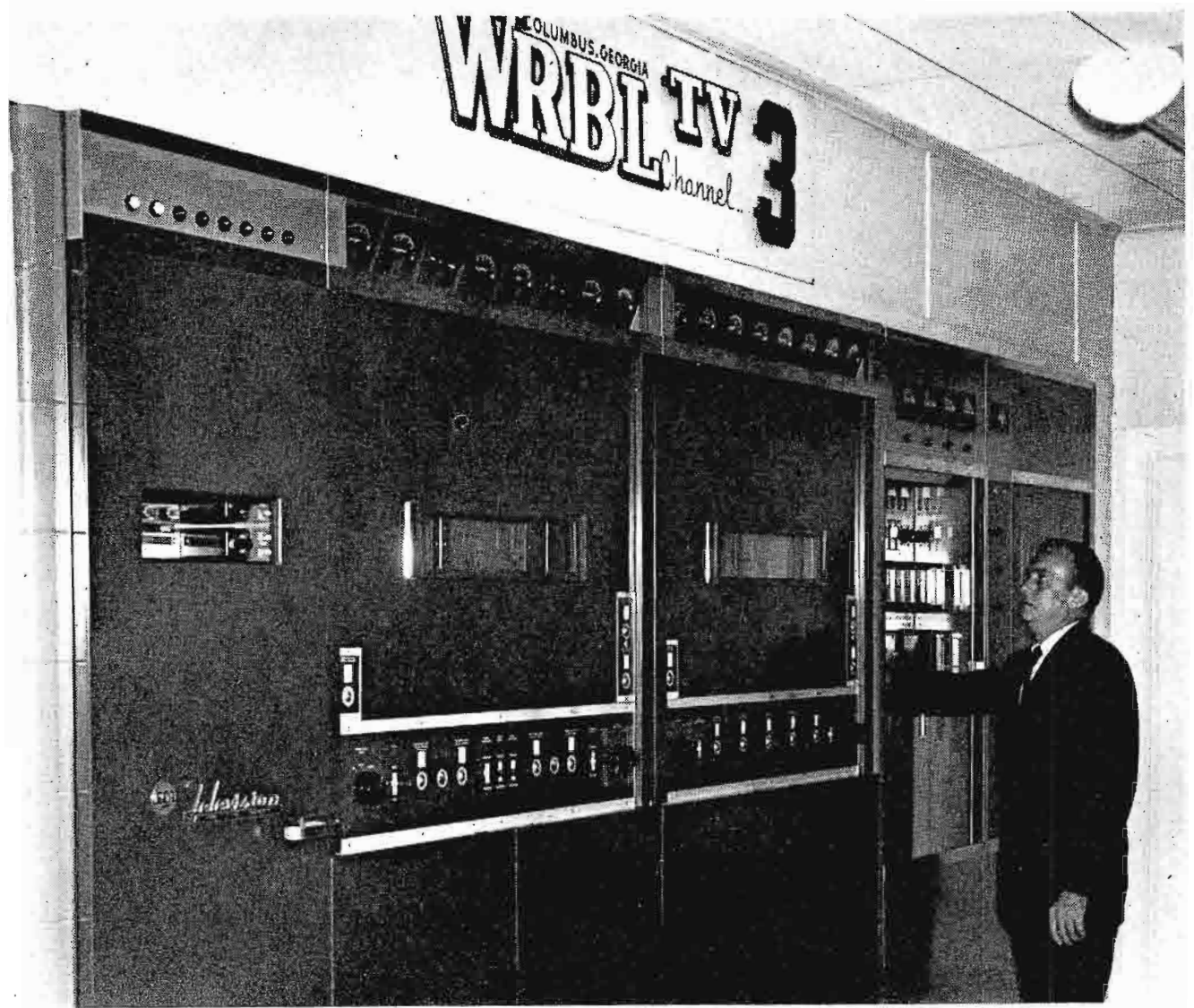

FIG. 8. WRBL-TV employs 25-kw Type TT-25CL TV transmitter.

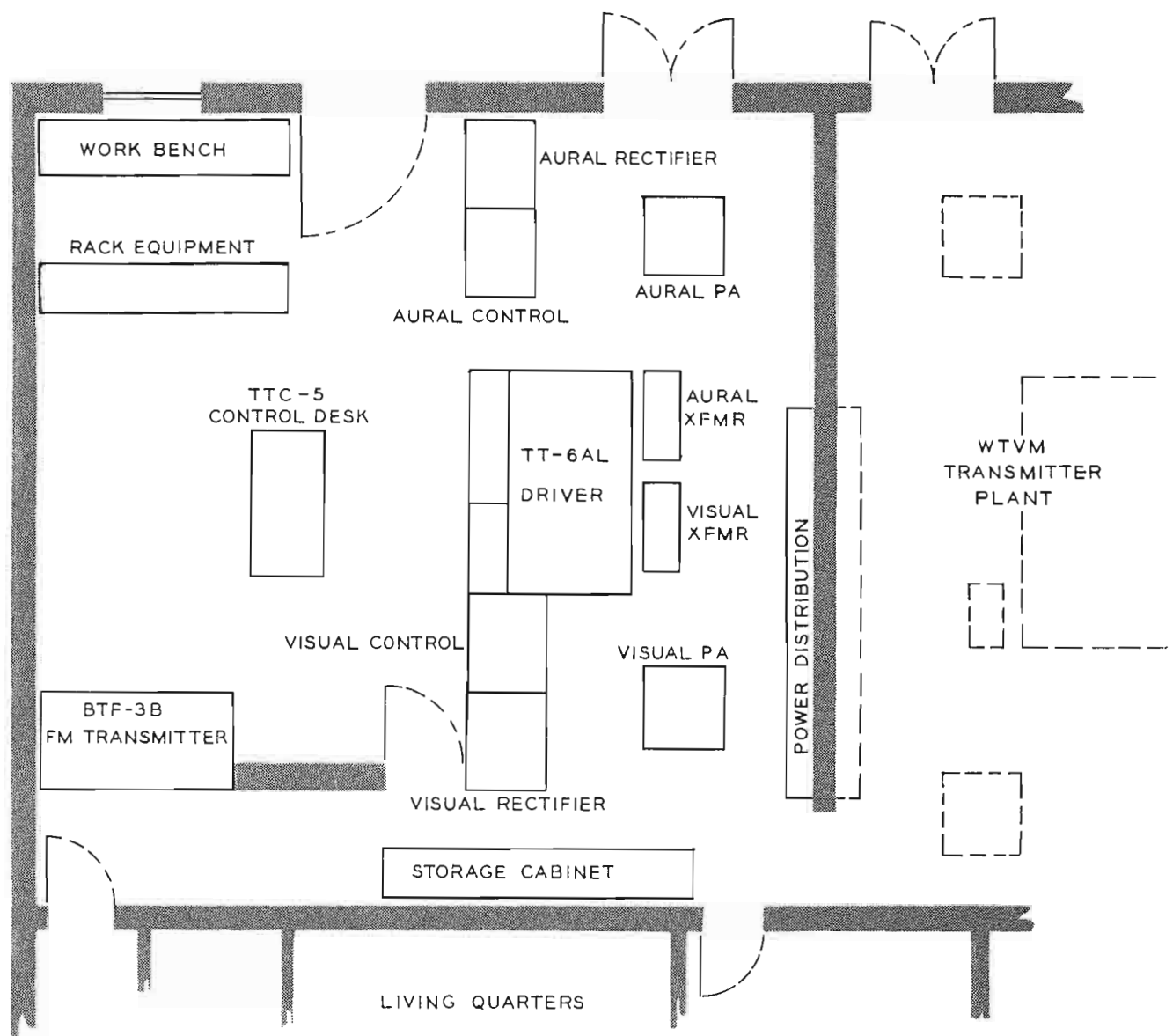

FIG. 9. WRBL's transmitter plant floor plan. The station shares the building as well as the tower. Transmitter personnel live in the "front" part of the building.



FIG. 1. E. D. Martin, President, Martin Theaters of Georgia, Inc.



FIG. 2. Roy E. Martin, Jr., Vice President.

WTVM

OPERATING CHANNEL 9 FROM WORLD'S HIGHEST STRUCTURE

Now Serves as Far as Macon, Albany and
Montgomery with Unduplicated ABC Programming

In 1953, Columbus had a two TV-channel allocation: 4 and 28. WDAK-TV went on the air during October of that year using Channel 28.

The de-intermixture proceedings of 1957 dissolved the Channel 28 allocation and replaced it with Channel 9 from Dothan (Ala.). The Columbus Channel-4 allocation went to Dothan and was replaced with a Channel 3 assignment, which WRBL-TV now occupies.

In 1957, Martin Theaters of Georgia (Inc.) acquired full ownership of Channel 28 and changed the call to WTVM. Almost immediately, plans were started to move the station to Channel 9.

WTVM went on the air on Channel 9 during 1960, sharing a 1260-foot tower with WRBL-TV at a site 16½ miles southeast of Columbus, near Cusseta, Ga.

WTVM Management

WTVM is a division of Martin Theaters of Georgia, a privately-owned corporation under the control of President E. D.



FIG. 8. WTVM film programming starts here. Herman Ragland loads the Type TP-7 Slide Projector which works into the TP-11 Film Multiplexer. The two 16-mm projectors are TP-16 units. The pickup is via RCA vidicon camera.



FIG. 3. C. L. Patrick, Executive Vice President



FIG. 4. Reeve Owen, V.P. & Gen. Mgr., WTVC, Chattanooga, Tennessee.



FIG. 5. Joe Windsor, WTVM General Manager.



FIG. 6. Ted C. Short, WTVM Station Manager.



FIG. 7. Charles Parrott, WTVM Chief Engineer.

Martin, Vice President Roy E. Martin and Executive Vice President C. L. Patrick. *Martin Theaters* also owns WTVC (Channel 9) in Chattanooga of which Reeve Owen is Vice President and General Manager. Mr. Owen only recently transferred to Chattanooga from WTVM and, as Vice President and General Manager of the Columbus operation, conceived and planned the combined operation of WTVM and WRBL-TV.

FIG. 9. Program control room at the downtown studio. John Stikes (through glass) announcing; Don Watson at switcher and Herman Ragland at camera control unit.



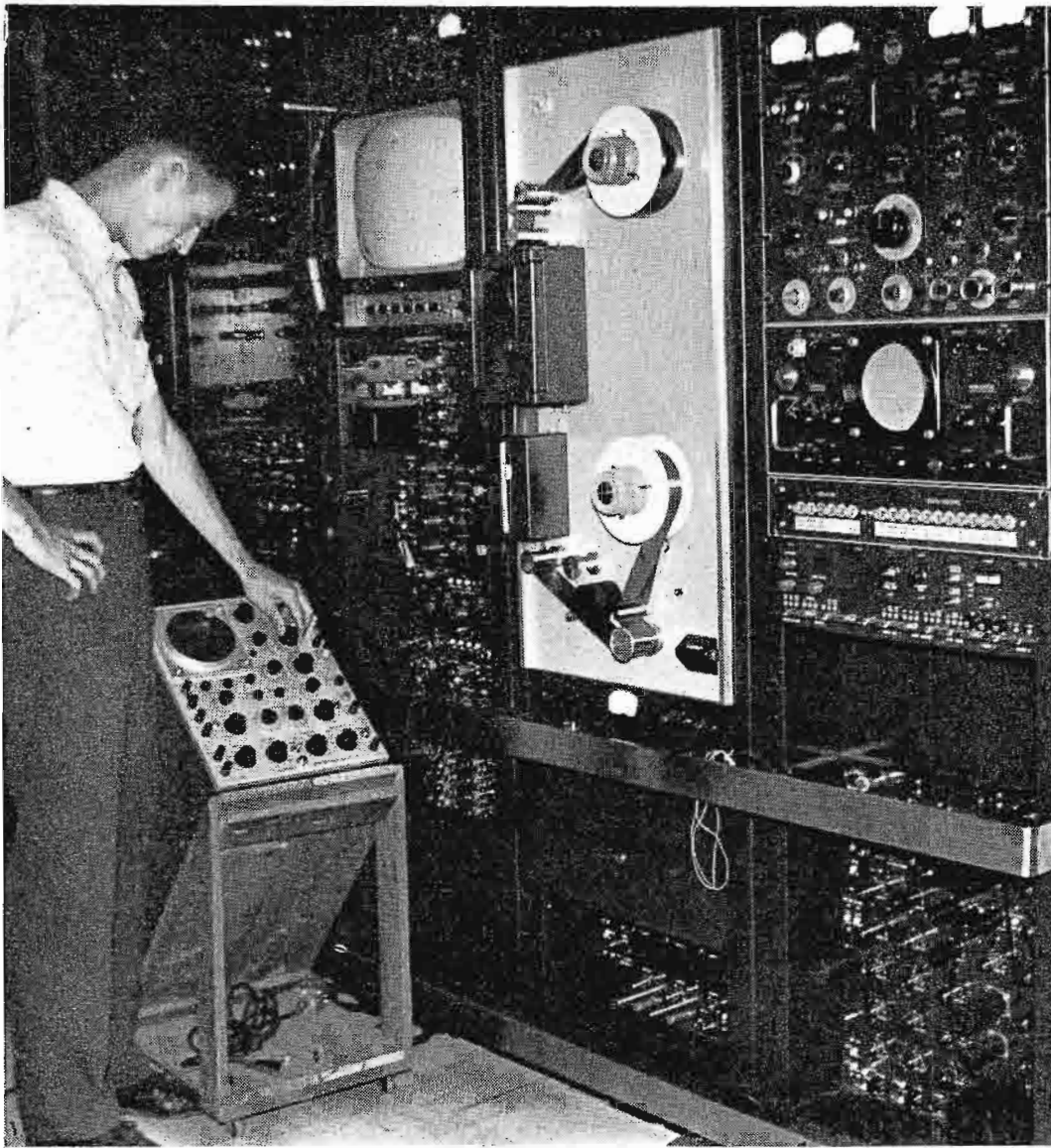

FIG. 11. RCA TRT-1B TV Tape facility in the control room at the downtown studios. WTVM uses this recorder for commercial spots and programs.

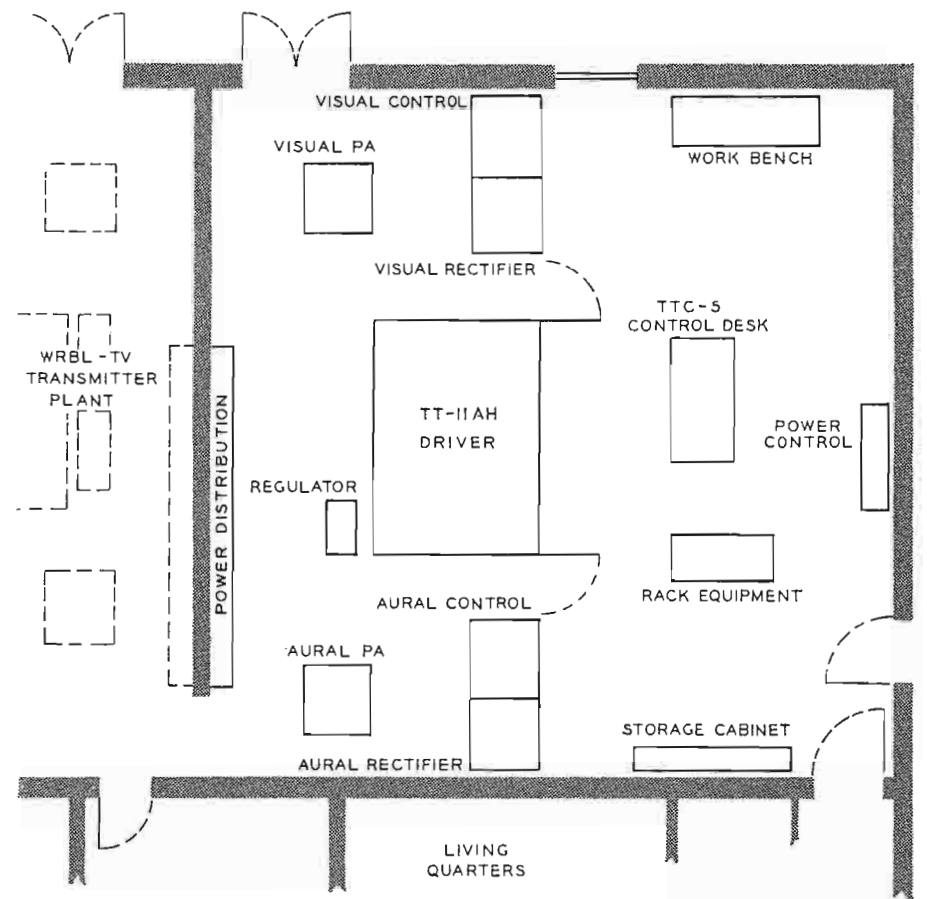

FIG. 10. WTVM shares the transmitter building with WRBL-TV. This floor plan illustrates the roomy, well laid-out plant.



FIG. 12. WTVM transmitter plant. In foreground is the TTC-5 Control Console. At far background are the rectifier and control cabinets for the TT-25CH aural power amplifier.



FIG. 13. One of the two r-f power amplifiers located to the rear of the driver of the transmitter (see FIG. 10). Primary-power switching devices on rear wall.



FIG. 14. Peter Cole, WTVM News Director, on the set for the 5-minute newscast at 7:25 A.M.

Joe Windsor is now general manager of WTVM with Charley Parrott serving as chief engineer. Ted Short is station manager and Jack Poole is director of operations.

Network Service

As a result of the change in allocations for the area, WTVM is the only primary-ABC outlet between Atlanta to the north and the Gulf of Mexico to the south and, as such, the only station serving Macon, Albany and the Columbus-Phenix City area with an unduplicated Grade "B" television service.

WTVM's weekly schedule totals 121½ hours of air-time, 15 percent of which is live programming.

Studios and Offices in Downtown Columbus

Staffed by 38 full-time employees, WTVM occupies a three-story building located at 1307 First Avenue. General Manager Joe Windsor heads a management team with an average age of only 35 years . . . one of the reasons for WTVM's great business success.

The pictures on these pages indicate the quality of the facilities WTVM operates, using the finest of broadcast equipment.

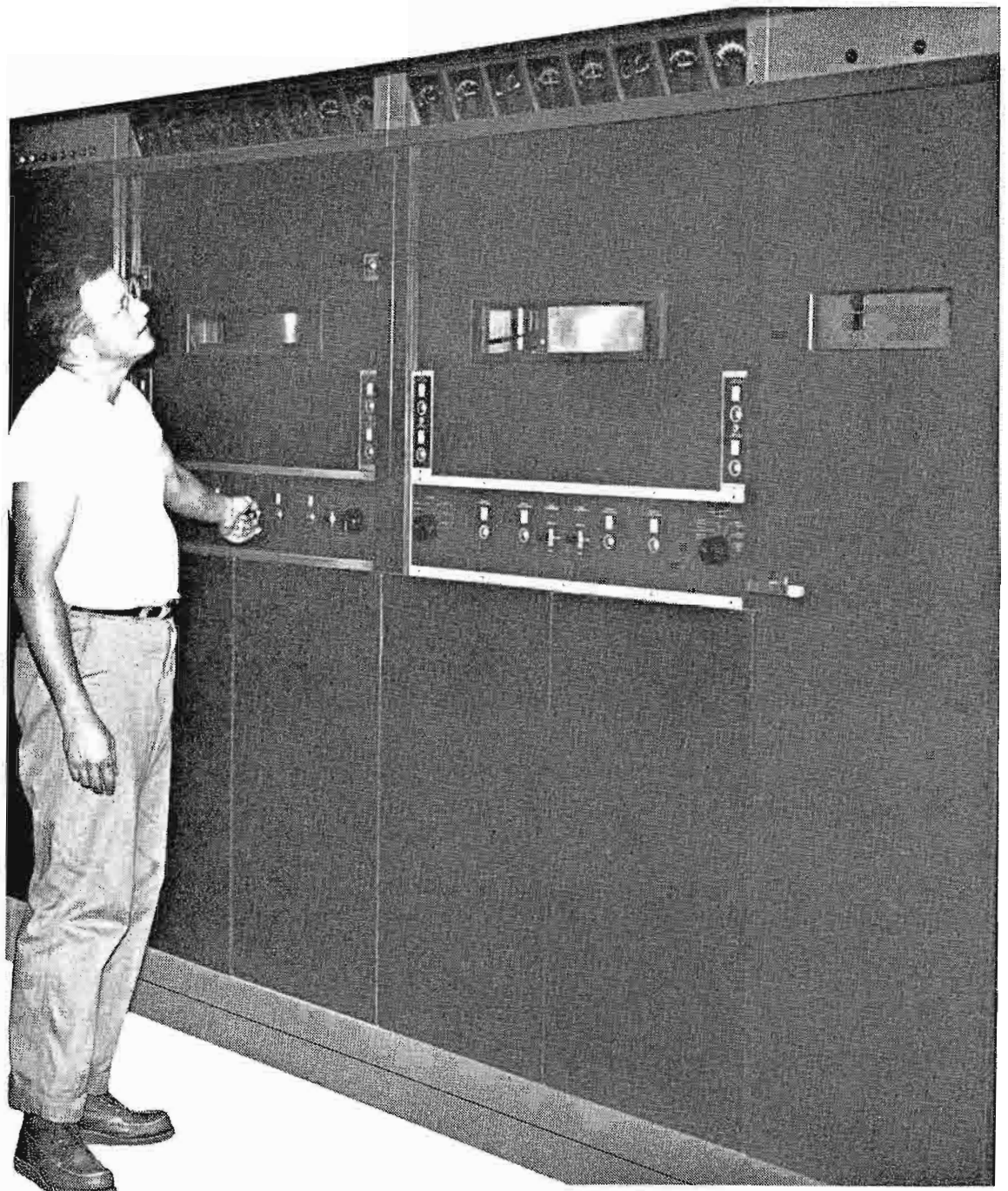

FIG. 15. The transmitter driver . . . an RCA TT-11AH . . . which drives the TT-25CH power amplifiers. Making a routine check is John Maxwell, resident engineer.

JACK LEITCH RETIRES

BROADCAST NEWS will never be quite the same. Neither will the broadcasting industry—at least, the technical side of it. For Jack Leitch has retired. We couldn't believe it when he first told us. But it's true—on June 1, he took down his ticket and drove off to his seven acres of yard and garden.

It doesn't seem quite right. He's too young. He's got more drive than men half his age. And he's our favorite author. What will we do without him?

Not that he hasn't earned a little time off. When we first met Jack—and that would have been

1930 or 1931—he already had a considerable career behind him. He had been a "wireless operator" in the Army, traveled the world as a ship's operator for Marconi and as Radio Officer in the Merchant Marine, had been a ship's radio inspector for RCA and then a Federal Radio Inspector. He was "RI" in the Philadelphia office from 1924 to 1928, as many an early broadcaster will well remember. Not the least of these was Dr. Leon Levy, then joint owner and General Manager of WCAU. And that led to Jack's appointment in 1929 as Chief Engineer of WCAU.

It was early in the game (the total income of all the broadcasting stations on the air in 1929 was less than \$30 million). But Jack Leitch and Dr. Levy had a vision of the years to come—and they were determined to make WCAU the best equipped station in the country.

By 1931 (when BROADCAST NEWS came on the scene), they were in the midst of installing an RCA 50-B Transmitter in what was probably the world's first truly modern transmitter building. With it went a 500-foot, guyed, vertical radiator (the second in the country). At the same time they were putting the finishing touches on a 9-story studio building on Chestnut Street in downtown Philadelphia. It was the bottom of the depression—but WCAU was building for the future. They spared no expense, cut no corners, demanded the best and newest in equipment.

Among other things Jack Leitch insisted that he must have something better than condenser microphones. To meet his demand we brought from the laboratory the velocity microphone on which Dr. Olson was just completing his work. Thus WCAU became the first station to be equipped with the famous 44A Microphone—the microphone which was to be preeminent for a decade—and which in new versions is still first choice for fine studio sound pickup.

To go with the velocity microphones Jack demanded—and got—the first large-scale, all-a.c.-operated studio equipment installation. He also got the first RCA transcription turntables, the first

RCA custom-built audio control-consoles and many other innovations which were to set the trend in studio equipment design for two decades.

All of this happened at just the time we were starting BROADCAST NEWS. So it was not surprising that we turned to WCAU for material to fill our pages. Certainly proximity, and the happy coincidence that WCAU was using mostly RCA equipment had something to do with it. But mostly it was because we were so tremendously impressed with what WCAU was doing—and the way Jack Leitch was doing it.

Thus it was that there appeared in the April 1933 issue of BROADCAST NEWS—which was then just seven issues old—a detailed, and beautifully illustrated article describing the glossy new studios of WCAU (see opposite page). It was the first of the "long" station stories which were to become the hallmark of our magazine. And it was a wondrously happy choice, for the new WCAU studios turned out to be the finest that had ever been built—and, although some studios built later may have come close, none ever managed to surpass WCAU, in appearance, in spaciousness, in facilities or in convenience of arrangement.

In the past thirty years we have visited hundreds of stations the country over—but none, we think, have matched those early WCAU studios for sheer beauty. Their glass and stainless steel motif would be considered "modern" today—in 1932, it was out of the then world. The studio wall designs and murals were personally done by John Vassos. In fact we first met John dressed in a smock and beret, (he won't like us for that) up on a ladder painting a mural in WCAU's Studio C.

But what would most surprise today's young squirts would be the size of those studios. There were seven of them (not counting an auditorium studio added later). The largest was 55 by 32 feet by 23 feet high. Two others were nearly as large. Even the smallest (22 feet by 12 feet) was large by today's standards. Just imagine that, kids—and all of it just for radio!

It paid off. WCAU became as successful as it was striking. And as the station grew in prestige, Jack Leitch broadened his activities and became one of the technical leaders of the industry. He worked with Leopold Stokowski in perfecting the technique of symphony pickups—and built for the irascible orchestra leader a novel, light-beam volume indicator. He developed a workable electronic organ. He and his engineers installed the first sound-reinforcing systems for Robin Hood Dell in Philadelphia and Lewisohn Stadium in New York. Not infrequently RCA engineers called on him to test and evaluate new ideas and equipments. For example, many of the field measurements which Dr. G. H. Brown used to check his



1963 John G. Leitch who as chief engineer, technical supervisor, technical director and vice president directed the technical planning and operation of the WCAU stations from 1929, until his retirement on June 1, 1963.

WCAU A Modern Monument to the Art of Broadcasting

By JOHN G. LEITCH, Technical Supervisor, WCAU

When the new WCAU building was completed in 1933, it was a landmark in the history of broadcasting. It was the first building in the world to be designed specifically for the purpose of broadcasting. The building was designed by the architect, Frank Lloyd Wright, and it was built by the WCAU Corporation. The building is a masterpiece of modern architecture and it is a monument to the art of broadcasting.



JOHN G. LEITCH, Technical Supervisor, WCAU

The building is a masterpiece of modern architecture and it is a monument to the art of broadcasting. It was designed by the architect, Frank Lloyd Wright, and it was built by the WCAU Corporation. The building is a landmark in the history of broadcasting and it is a masterpiece of modern architecture.



DR. LEON LEVY

Dr. Leon Levy is a prominent figure in the field of broadcasting. He has been instrumental in the development of the new WCAU building and has played a key role in the station's operations.

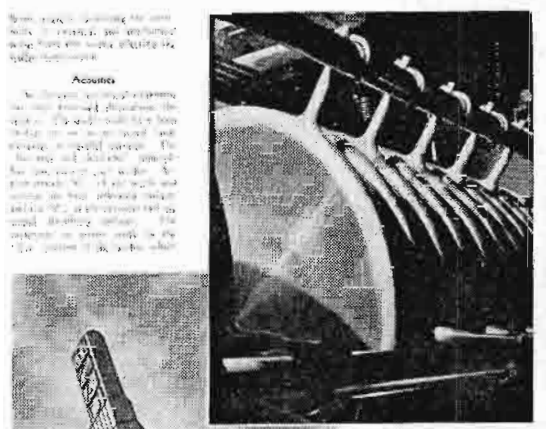

The interior of the WCAU building, showing the complex arrangement of radio equipment and control panels.

1933 Feature story of BROADCAST NEWS No. 7, April 1933, was Jack Leitch's 14-page story describing the new studio building of WCAU. Replete with many photographs and drawings it set a pattern for future station stories.

The building is a masterpiece of modern architecture and it is a monument to the art of broadcasting. It was designed by the architect, Frank Lloyd Wright, and it was built by the WCAU Corporation. The building is a landmark in the history of broadcasting and it is a masterpiece of modern architecture.

The building is a masterpiece of modern architecture and it is a monument to the art of broadcasting. It was designed by the architect, Frank Lloyd Wright, and it was built by the WCAU Corporation. The building is a landmark in the history of broadcasting and it is a masterpiece of modern architecture.

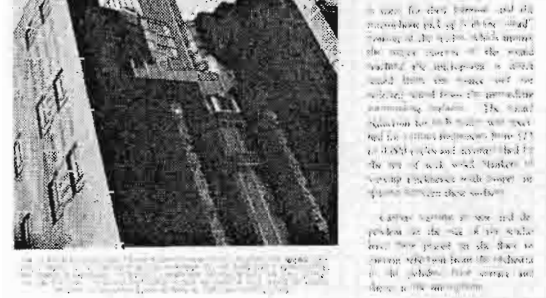

The exterior of the WCAU building, showing its distinctive Art Deco architectural style.

1949 Feature story of BROADCAST NEWS No. 54, April 1949, was a 22-page story by Mr. Leitch describing the conversion of the earlier radio studios for TV use. Like the previous story it became a primer for other stations making similar plans.

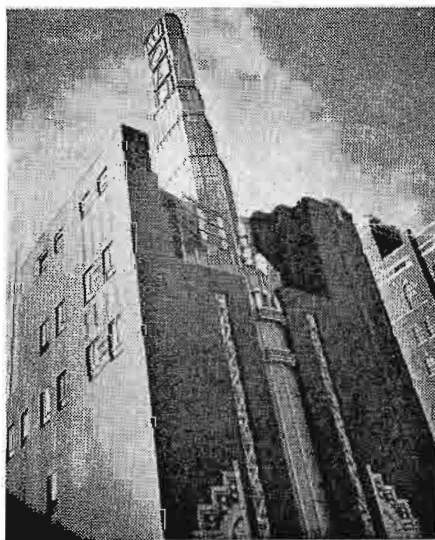

by JOHN G. LEITCH

Technical Director, WCAU-TV

The conversion of the earlier radio studios for TV use was a significant milestone for WCAU-TV. It allowed the station to expand its programming and reach a wider audience.

The conversion of the earlier radio studios for TV use was a significant milestone for WCAU-TV. It allowed the station to expand its programming and reach a wider audience.

WCAU-TV

The conversion of the earlier radio studios for TV use was a significant milestone for WCAU-TV. It allowed the station to expand its programming and reach a wider audience.

The conversion of the earlier radio studios for TV use was a significant milestone for WCAU-TV. It allowed the station to expand its programming and reach a wider audience.



JOHN G. LEITCH, Technical Director, WCAU-TV



WCAU-TV-10 logo with the slogan 'FAIR AND COOLER'.

The conversion of the earlier radio studios for TV use was a significant milestone for WCAU-TV. It allowed the station to expand its programming and reach a wider audience.

1953 Feature story of BROADCAST NEWS No. 72, January-February 1953, was this 26-page story describing the plant that Jack built to house all of WCAU's radio and TV activities. Probably the finest and most detailed story of this type ever published anywhere it completed a remarkable trilogy of one station's progress.

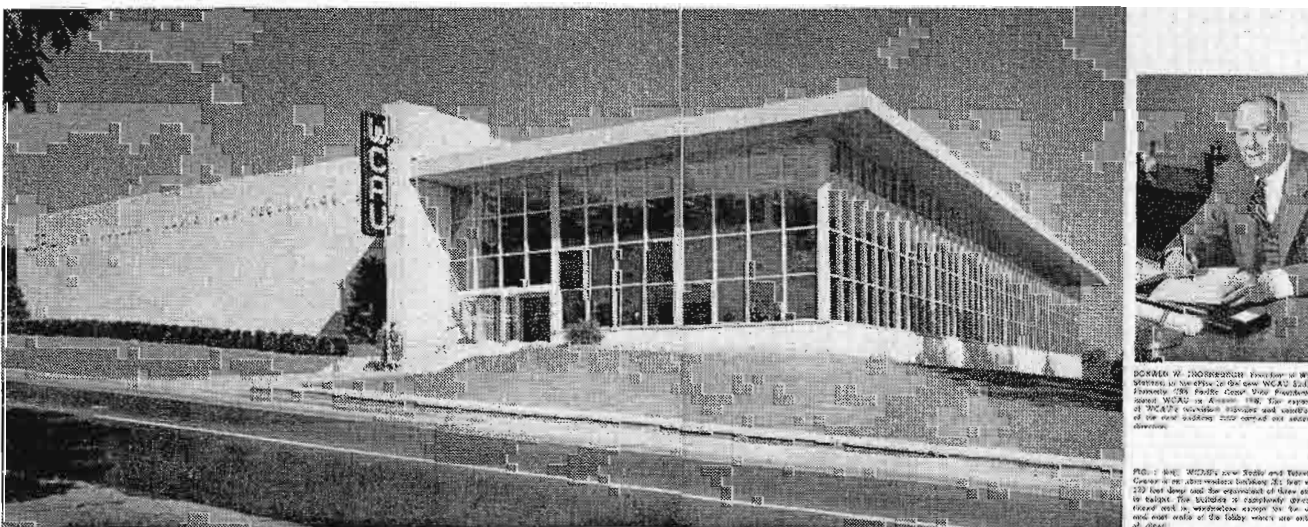

The exterior of the WCAU's new Radio & Television Center, a modern building with large windows.



JOHN G. LEITCH, Vice-President in Charge of Engineering, WCAU

WCAU's NEW RADIO & TELEVISION CENTER

Philadelphia Bulletin Stations' New Studio Building Features Functional Design and Complete Integration of Radio and Television

The new WCAU building is a masterpiece of modern architecture and it is a monument to the art of broadcasting. It was designed by the architect, Frank Lloyd Wright, and it was built by the WCAU Corporation. The building is a landmark in the history of broadcasting and it is a masterpiece of modern architecture.

WCAU's NEW RADIO & TELEVISION CENTER

Philadelphia Bulletin Stations' New Studio Building Features Functional Design and Complete Integration of Radio and Television

The new WCAU building is a masterpiece of modern architecture and it is a monument to the art of broadcasting. It was designed by the architect, Frank Lloyd Wright, and it was built by the WCAU Corporation. The building is a landmark in the history of broadcasting and it is a masterpiece of modern architecture.



NORMAN W. ZIMMERMAN, President, WCAU

Norman W. Zimmerman is the President of WCAU. He has been instrumental in the development of the new WCAU building and has played a key role in the station's operations.

Norman W. Zimmerman is the President of WCAU. He has been instrumental in the development of the new WCAU building and has played a key role in the station's operations.



1943 Lt. Commander John G. Leitch as Officer-in-Charge, U.S. Naval Station, Greenland.

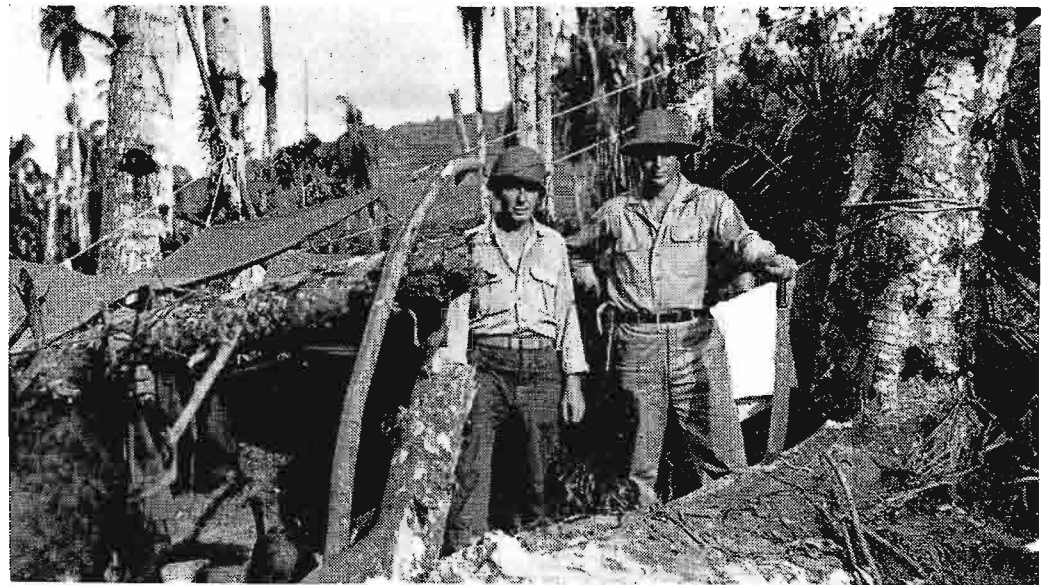

1943-45 From the Arctic to the tropics—Lt. Com. Leitch with the Attack Forces; Gilberts, Marshalls and Marianas.

calculations on antenna radiation were made at WCAU with the assistance of Jack and his crew.

All of these accomplishments, and others, were duly reported in BROADCAST NEWS issues of the thirties. Came 1941, and both Jack and BROADCAST NEWS went off to war. Entering the Navy as a lieutenant he emerged as a full commander and is now Captain, USNR, Retired. A brilliant record is compressed here into two pictures; one of Jack as Officer-in-Charge of U.S. Naval Station, Greenland, and a second, as a member of the attack forces for the Gilberts, Marshalls and Marianas. Later he served on the staff of Admiral Nimitz and the staff of the Chief of Naval Operations in Washington.

With the end of the war Jack returned to WCAU—and once more things began to happen thereabouts. A construction permit for TV was granted in September 1946, and WCAU-TV went on the air in May 1948.

When the radio studios described above were built in 1931, Jack Leitch and Dr. Levy had discussed the possibility that TV would someday "turn the corner." And plans were made then to permit the adaptation of the building to television. It would be folly to claim that all the requirements were foreseen. But the very size of the WCAU radio studios, their height, the placement of observation booths on a level above the studio floor and the provision of spiral stairways from upper booths to the studio floor were features of the original installation that made conversion to TV relatively easy.

Such conversions of radio studios for TV were typical in the first post-war years. The WCAU operation was outstanding and was of great interest. In another "long" story with many illustrations and drawings in the April 1949 issue of BROADCAST NEWS Jack Leitch told how it was done. The story became a primer for stations that followed.

But nobody foresaw TV's hungry demand for space—for prop-storage, for equipment, for lights—and for the myriad of personnel. WCAU-TV's make-do, like all others, soon became unbearably cramped.

And so Jack Leitch began the planning of a "Radio and TV Center" which would be a plant for the future—to serve, as his 1931 Studio had served for 20 years. He set out to build the biggest and the best. And he did just that. The studio plant he created for WCAU and WCAU-TV became the focus of attention for all the chief engineers who were dreaming of new plants. It was the first big and elaborate TV setup. And its features were widely copied. Like its predecessor, the new WCAU center was unequalled when it was built and has been unsurpassed by anything built since. Constructed in the heyday of local TV programming, as the original 1932 building was built at the

zenith of local radio programming, the WCAU Center is notable for its spaciousness and for the facilities and flexibility provided for local programming.

Once again Jack Leitch had set a pattern which a whole industry was to follow. And once again he wrote it up in what is probably the most carefully illustrated and detailed article we have ever printed in BROADCAST NEWS. We have reproduced here the lead pages from the three "long" stories which Jack Leitch wrote for us. He also wrote a number of shorter stories—and furnished material for still others. All told BROADCAST NEWS has carried some dozen articles on WCAU.

So now you know why BROADCAST NEWS will miss him so!

The industry will miss him, too. Partly because his experience, his knowledge and his drive have made him one of its technical leaders. But more so, perhaps, for his strong personal traits. These are many, but the two which stand out most to us are: first, the willingness with which he would try a new idea or new equipment, and second, the certainty that he would express a carefully considered, but very, very frank opinion about it. This frankness, coupled with a natural parsimony with words, could add up to some very brusque remarks—as we have cause to know.

At the time of our first meeting with Jack we were the youngest and greenest of RCA salesmen. As mentioned previously, he was then installing an RCA 50-B Transmitter and new RCA studio equipment. It was our job to maintain liaison (which is a polite expression for "you tell him we're going to be late"). Suffice to say, that after that initiation nothing that happened later ever scared us very much.

We never did learn how much of that hellfire he radiates when perturbed is really tongue-in-cheek. But when we recovered enough to look, we noted that there was a crinkle of humor around the edges of those penetrating see-right-through-you-eyes. And we soon learned that he would lean over backwards to be fair, that his actions were always those of a gentleman, and that when he relaxed a little, he was a very interesting conversationalist.

We came to value his opinions and to enjoy our contacts with him. We feel sure that all those who know him well share this feeling. And we certainly hope that his retirement from active station work will not change this.

When we asked Jack what he was going to do, he said, "I don't know"—and that was certainly typical. But we have a feeling that anyone who has broadcasting in the blood the way Jack does, will not lose it overnight—and we certainly hope not.

The industry needs his pungent evaluations—and BROADCAST NEWS needs his articles.

—JPT

PICTURES OF WCAU STUDIOS BUILT IN 1932

- REPRODUCED FROM BROADCAST NEWS, APRIL, 1933



Studio A, 55 feet long, 32 feet wide, 23 feet high. Three windows at top are in observation gallery. Control room is in center below.

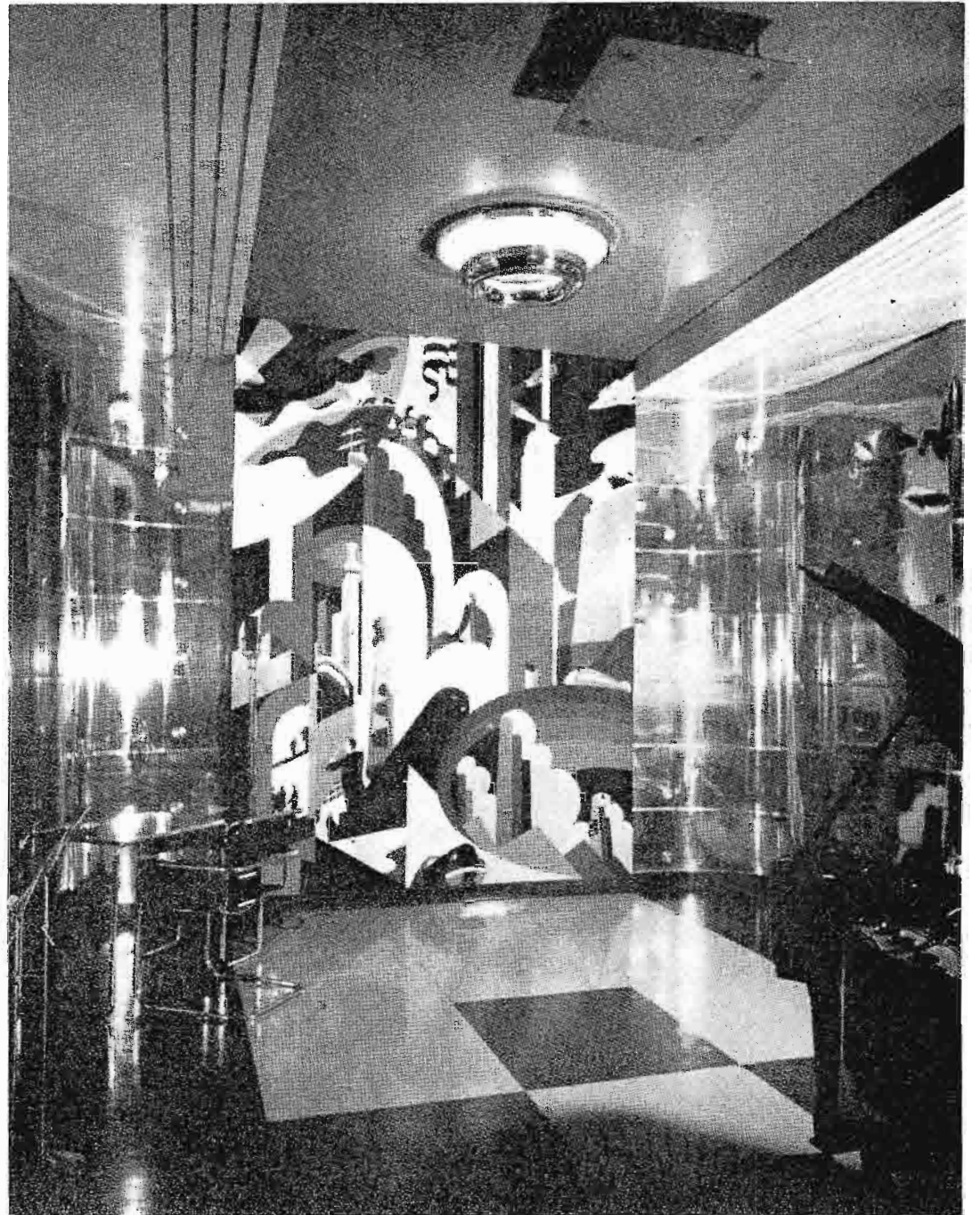

Studio J, the smallest studio, 22 feet long, 12 feet wide. This and other studios had murals designed by John Vassos.

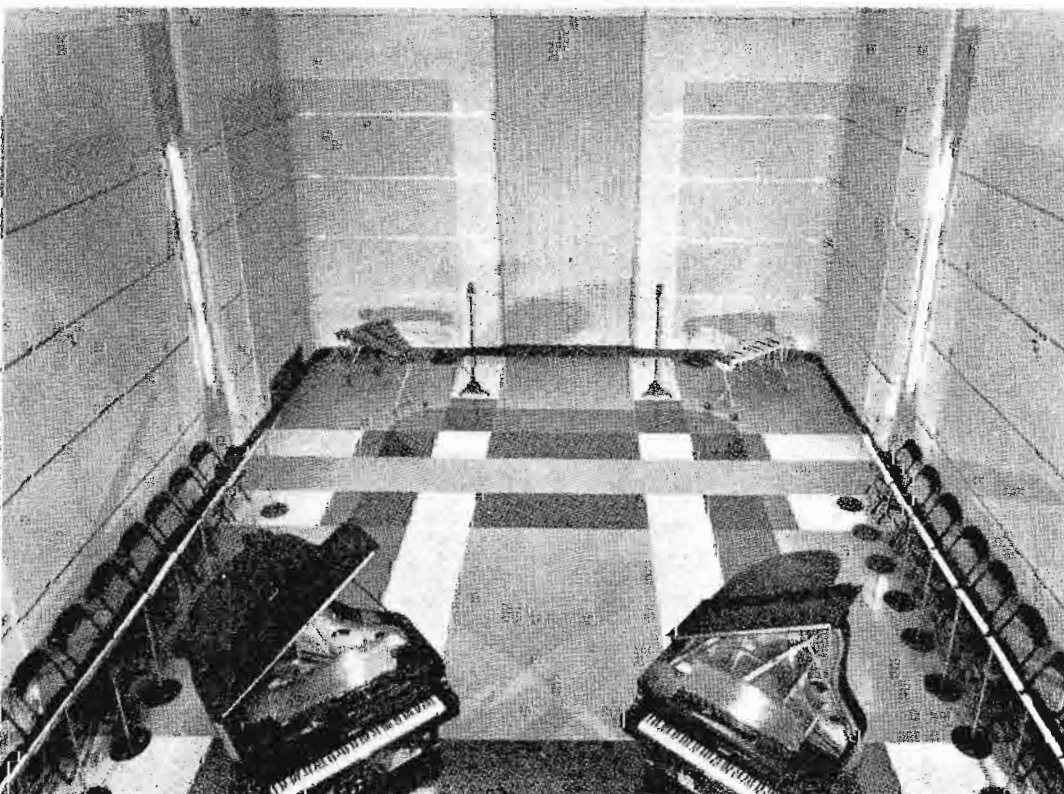

Studio B, approximately the same size as Studio A. This is a view looking from the observatory gallery toward the "dead" end.



Studio D, another two-story-high studio nearly as large as A and B, was decorated with electronic motifs woven in tapestry covering walls.

RCA SERVICE

keeps all your
AM, FM, TV
equipment
in top
condition!

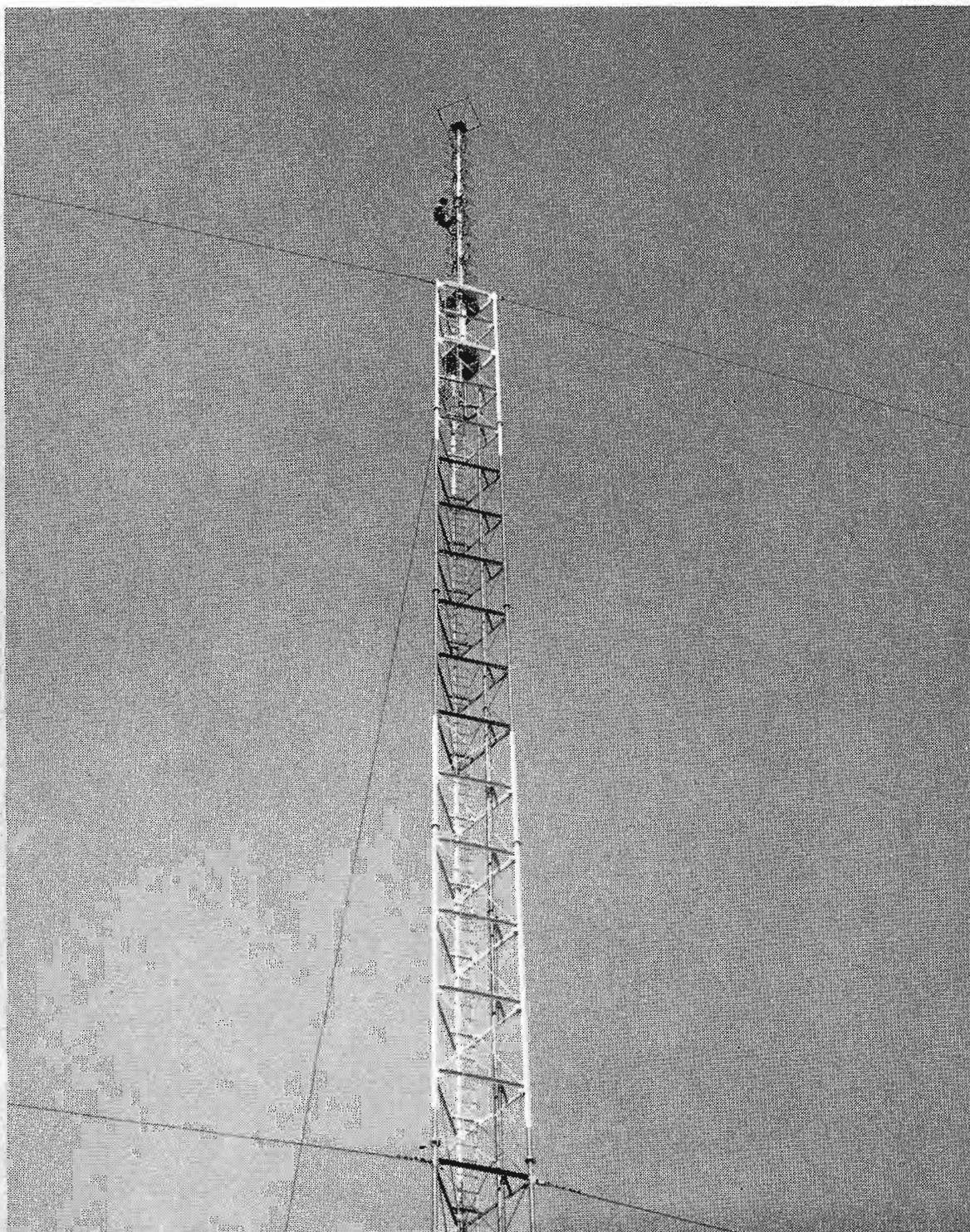

Antenna System Measurements

Your audience demands a superior signal which requires top performance from all your station equipment. RCA Broadcast Service is planned

to assure you of meeting this objective. More than 30 years in the broadcast industry have provided a background of solid service experience.

TAKE ADVANTAGE OF THE FOLLOWING SERVICES OFFERED BY RCA:

**Video Tape Recorder Service • TV Camera Overhaul • TV Transmitter Overhaul
• Installation Supervision • Microphone and Pick-Up Repairs • Transmitter Performance
Measurements • Antenna Inspection Measurements • Console Repairs • Microwave Service
• TV Projector Service • Custom Fabrication • Teletypewriter Maintenance**

This is the type of protection broadcasters have relied on for years, the kind of protection you can count on . . . contract or per-call . . . from the experts in the service business, RCA Service Company. To guard performance of all your equipment . . . simply telephone one of the

following field offices: Atlanta (phone 799-7291), Chicago (WE 9-6117), Camden (GL 6-7984), Hollywood (OL 4-0880). Or contact Technical Products Service, RCA Service Company, A Division of Radio Corporation of America, Bldg. 203-1, Camden 8, N.J.



The Most Trusted Name in Electronics

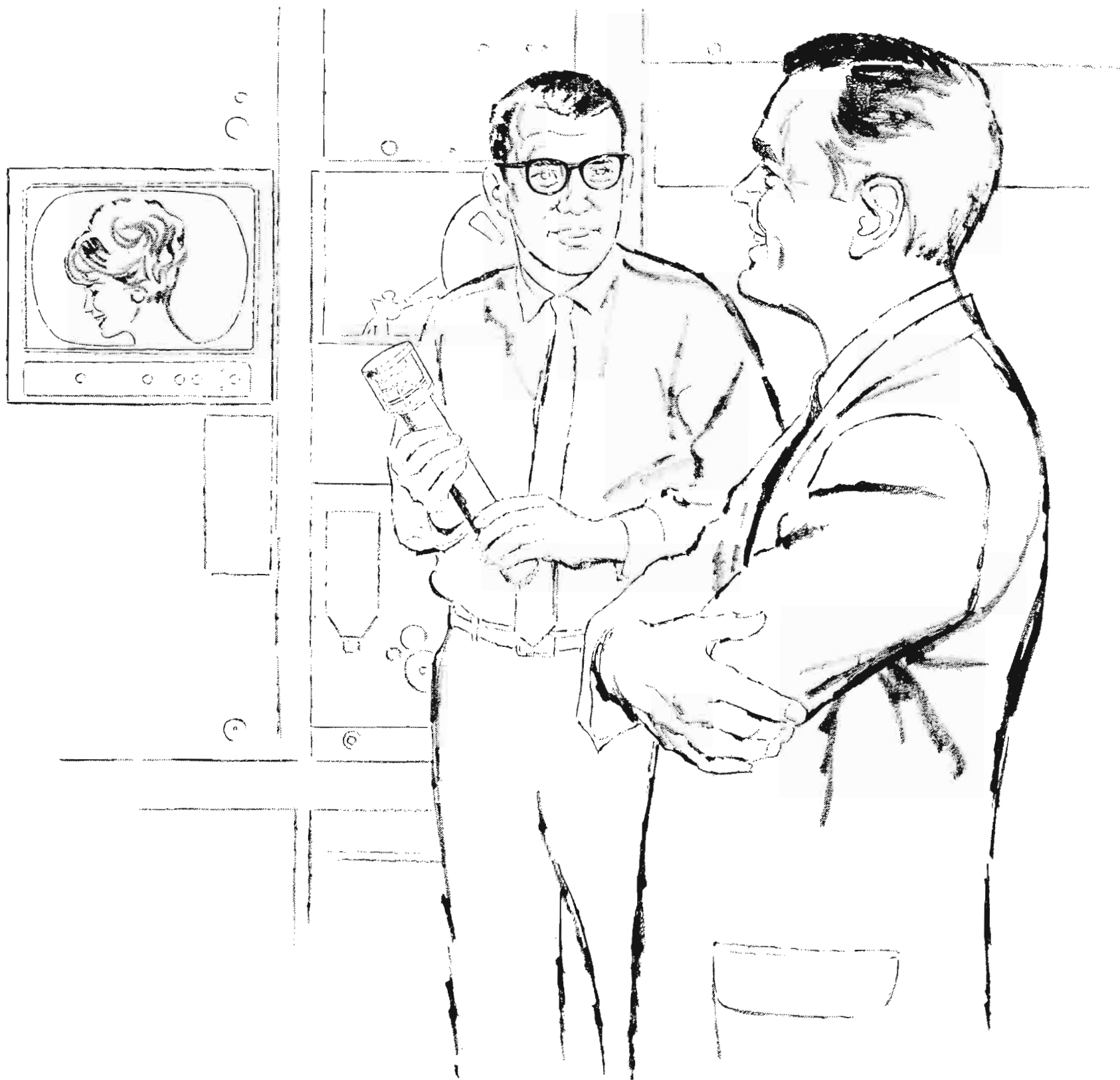

Sponsor Preferred

Choose RCA-4415 & 4416 for Your Big Year in Color

Colorcast schedules are growing heavier. And heavier. And heavier. Get set now to deliver the sharp, true, bright pictures sponsors demand for their programs and commercials. Replace with RCA Image Orthicons 4415 & 4416. For RCA insists on highest quality performance in its color image orthicons. And has invested more to get it.

The RCA 3-tube factory-matched set in your camera produces exceptional pictures in color receivers, as well as high resolution pictures with normal tone rendition in black-and-white sets... at lighting levels available in black-and-white studios! There's no problem of high scene-lighting temperatures...no need for extra air-conditioning. And

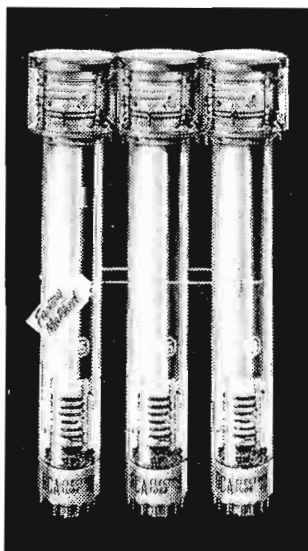

many lighting costs usually associated with highest quality indoor color pickup are avoided.

RCA precision construction, Field Mesh, plus finely matched tube characteristics assure you excellent picture registration and uniform color balance over the entire scanned area.

Also available is RCA-7513, an Image Orthicon for highest quality color pickup using conventional color TV lighting. Ask about RCA Image Orthicons locally. SEE YOUR AUTHORIZED DISTRIBUTOR OF RCA BROADCAST TUBES.

RCA ELECTRON TUBE DIVISION, HARRISON, N. J.



The Most Trusted Name in Television

For name and address of your local distributor write or call your nearest RCA Distributor Products Sales Office—New York, N. Y.: 36 W. 49th St., MUrray Hill 9-7200; Needham Heights 94, Mass.: 80 "A" St., Hillcrest 4-8480; Washington 7, D. C.: 1725 "K" St., S.W., FEderal 7-8500; Atlanta, Ga.: 134 Peachtree St., N.W., JAckson 4-7703; Cleveland, Ohio: 1621 Euclid Ave., CHerry J-3450; Chicago, Ill.: Merchandise Mart, 467-5900; Dallas 7, Texas: 7901 Carpenter Freeway, MEIrose 1-3050; Kansas City 14, Mo.: 7711 State Line, EMerson 1-6462; Los Angeles 22, Cal.: 6801 E. Washington Blvd., RAYmond 3-8361.

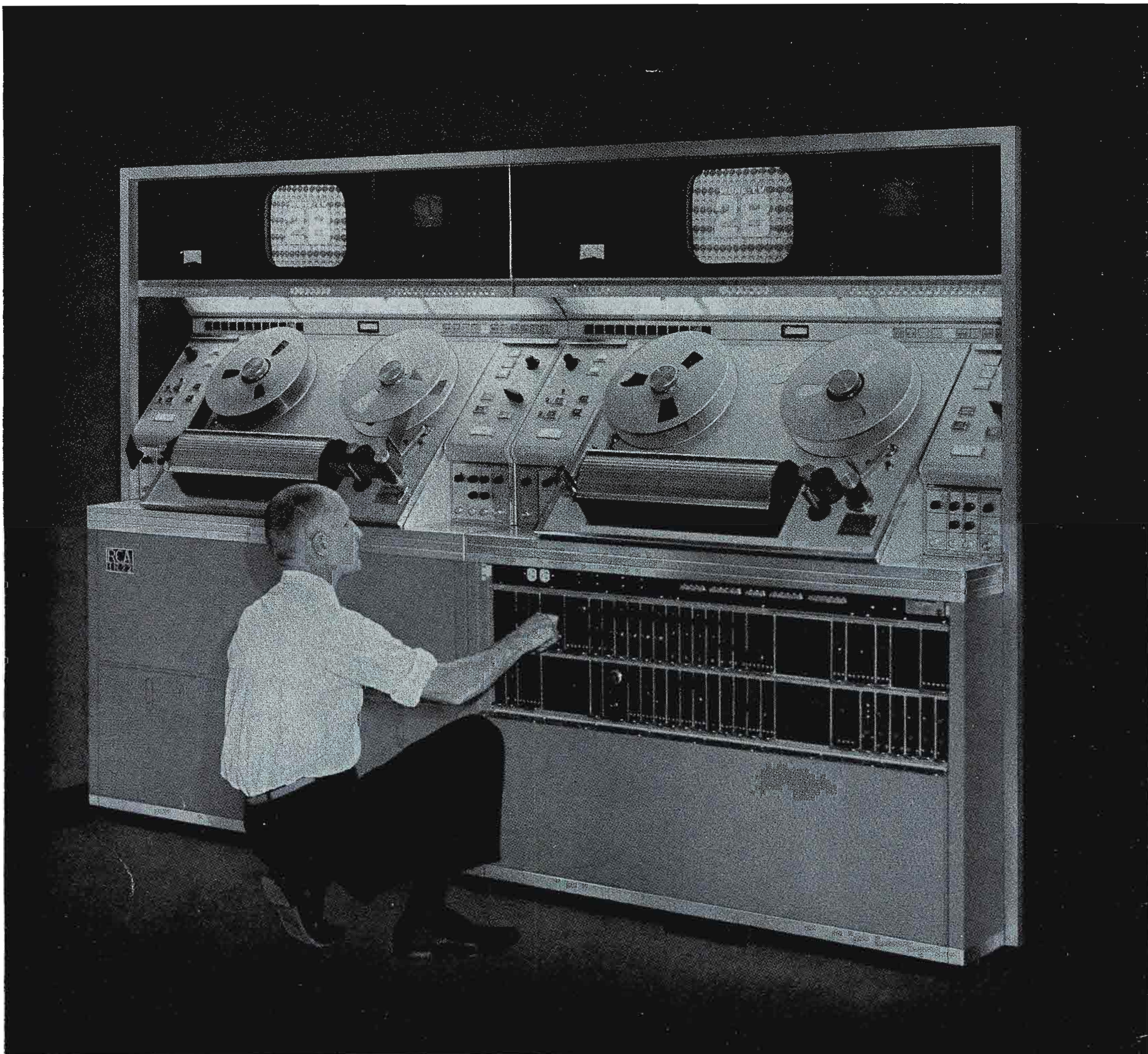

TAPE DUO DELUXE AT WBRE

"A Prestige Builder with Our Customers"

This is the look of leadership for the years ahead—new excellence of design and brilliant performance. With two TR-22 Deluxe TV Tape Recorders, this station can record on one unit while on air with the other. The two units occupy the space of a previous single tape unit.

Fully transistorized design does away with the problems of power and heat, reduces maintenance, and

assures a new standard of excellence. Clients are impressed with the efficient "look," the quality of performance, the increased versatility. It's a prestige builder with customers. Your own studio can benefit from this symbol of the finest in TV Tape.

See your RCA Representative. Or write RCA Broadcast and TV Equipment, Building 15-5, Camden, N.J.



The Most Trusted Name in Television